

HO  
RE  
CA  
line  
&plus  
2024



HO  
RE  
CA  
line  
&plus  
2024



Somos una empresa de  
fabricación de frío industrial

## especialistas en muebles de frío

para el canal Horeca y sistemas  
de dispensing tanto de cerveza  
como de agua



Nuestra empresa es la

## suma de talento, inquietud, equipos y fabricación

como respuesta a un proceso integral  
que unifica diseño y técnica, basado en  
tecnología, visibilidad y frío industrial

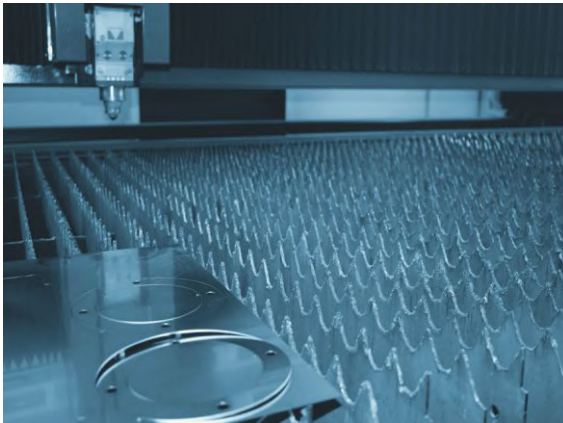

Contamos con más de

## 20 años de experiencia y más de 7.500 m<sup>2</sup>,

para ayudar a nuestros clientes  
a superar sus retos



## Innovación, tecnología y equipo humano

son nuestros valores principales



## HORECA line · HORECA plus

Nuestra colección LINE incluye una amplia variedad de familias de elementos destinados a completar la demanda del sector HORECA, con amplias opciones de elección y acabados en acero inoxidable.

Our LINE collection includes a wide variety of families of elements designed to complete the demand of the HORECA sector, with extensive customization options and stainless steel finishes.

Sin embargo, con nuestra colección PLUS, aportamos un punto más de exclusividad, posibilitando la configuración de los acabados del elemento, proporcionando valor añadido al mismo.

However, with our PLUS collection, we provide one more point of exclusivity, allowing the configuration of the element's finishes, providing added value to it.







**¿quieres personalizar los acabados de tu producto?  
descubre nuestra sección HORECA plus**

## Características generales **general characteristics**

-  Exterior e interior en acero inoxidable AISI-304 18/10, excepto trasera, ofrecido como opcional  
 AISI-304 18/10 stainless steel exterior and interior, except the rear side, which we offer as an option
-  Puertas con sistema de cierre automático  
 Doors with self closing system, blocked opening.
-  Luz interior LED incluida en todos los modelos con puertas de cristal. Led RGB ofrecida como opcional  
 Interior led light included in glass door models. RGB led as an option
-  Encimera de acero inoxidable AISI-304 18/10, con posibilidad de ser excluida, así como el peto sanitario de 100 mm, o bien fregadero (en los equipos con posibilidad)  
 AISI-304 18/10 stainless steel worktop, with the possibility of being excluded, as well as the 100 mm sanitary up stand, or sink (at models with compatible option)
-  Estantes interiores de varilla electrosoldada con recubrimiento de pintura. Resistencia máxima 10 kg.  
 Interior shelves of electro-welded rod with paint coating. Maximum resistance 10 kg.
-  Pies en tubo de acero inoxidable ajustables en altura 140-210 mm  
 AISI-304 18/10 adjustable legs, 140 to 210 mm
-  Unidad condensadora ventilada y extraíble  
 Removable and fan assisted condenser unit
-  Evaporador sistema tiro forzado, con recubrimiento anticorrosión  
 Fan assisted evaporator, with anticorrosion coating
-  Evaporación automática del agua de descarche de serie, excepto modelos de equipo remoto  
 Automatic evaporation of defrost water ass standard, except models with remote unit
-  Aislamiento de poliuretano inyectado, de densidad 40 kg/m3, bajo GWP y cero efecto ODP  
 40 kg/m3 density polyurethane insulation, low GWP and zero OPD effect
-  Control digital de temperatura y descarches, eficiente en la gestión del consumo de energía con display LED  
 Energy efficient digital controller of temperature and defrosts with LED display
-  Temperatura de trabajo a 32°C ambiente, posibilidad de equipo tropicalizado (43°C)  
 Operating temperature 32°C ambient, possibility of tropicalized group (43°C)
-  Cajoneras inoxidable refrigeradas desmontables sobre guías telescópicas con sistema de autocierre  
 Removable stainless refrigerated drawers on telescopic guides with self-closing system

## Leyenda de iconos icon index

 <p>Consumo (W)</p> <p>Consumption (W)</p>	 <p>Potencia frigorífica (W)</p> <p>Cooling capacity (W)</p>	 <p>Estantes</p> <p>Shelves</p>	 <p>Juego Guías</p> <p>Guide Sets</p>	 <p>Cajas 40x60</p> <p>Containers</p>
<p>Indica el consumo eléctrico total del aparato</p> <p>It indicates the total electrical consumption of the appliance</p>	<p>Capacidad total de energía frigorífica generada</p> <p>Capacity of cooling energy generated</p>	<p>Número de estantes de serie incluidos en el modelo concreto</p> <p>Number of standard shelves included in the specific model</p>	<p>Número de pares de guías incluidos en el modelo concreto</p> <p>Number of pairs of guides included in the specific model</p>	<p>Número de cajas incluidas en el modelo concreto</p> <p>Number of containers included in the specific model</p>
 <p>Rango de temperatura (°C)</p> <p>Temperature range (°C)</p>	 <p>Refrigerante Recomendado</p> <p>Recommended Refrigerant</p>	 <p>CEE</p> <p>ECC</p>	 <p>Capacidad (L)</p> <p>Capacity (L)</p>	 <p>Modelo de congelación</p> <p>Freezer model</p>
<p>Valores máximo y mínimo de temperatura de trabajo</p> <p>Maximum and minimum values of working temperature</p>	<p>Gas refrigerante. Se ofrecen dos alternativas, una de ellas como opción</p> <p>Refrigerant gas. We offer two alternatives, one of them as an option</p>	<p>Clasificación energética del modelo</p> <p>Energy classification of the concrete model</p>	<p>Volumen interior del modelo concreto</p> <p>Interior volume of the concrete model</p>	<p>Este icono aparece en los modelos de congelación</p> <p>This icon appears on freeze models</p>

## Mesas Undercounters

### Frentemostrador 600 series

MFR Frentemostrador refrigerado	MFR Back bar counter refrigerator	13
MFRC (puertas cristal)	MFR (glass door)	14
MFRGR (equipo remoto)	MFRGR (remote group)	15
MFR + cajones	MFR +drawers	16
MFR opciones	MFR options	17

<b>Frentemostrador PLUS line</b>		<b>18</b>
----------------------------------	--	-----------

### Bajo mostrador 600 series

MBR/MBRF Mesa baja refrigerada	MBR Undercounter refrigerator	22
MBRC (puertas cristal)	MBRC (glass door)	23
MBRGR (equipo remoto)	MBRGR (remote group)	24
MBR + cajones	MBR + drawers	25
MBC (congelación)	MBC (freezer)	26
MBCGR (equipo remoto congelación)	MBCGR (freezer remote group)	27
MBR/MBC opciones	MBR/MBC options	28

<b>Bajo mostrador PLUS line</b>		<b>29</b>
---------------------------------	--	-----------

### 700 series GN 1/1

MGR/MGRF Mesa gastronorm refr	MGR Gastro undercounter refrigerator	33
MGRC (puertas cristal)	MGRC (glass door)	34
MGRGR (equipo remoto)	MGRGR (remote group)	35
MGR + cajones	MGR + drawers	36
MGC (congelación)	MGC (freezer)	37
MGCGR (equipo remoto congelación)	MGCGR (freezer remote group)	38
MGR/MGC opciones	MGR/MGC options	39

### 700 series GN 1/1 bajo cocina

MGRBC Mesa gastronorm BC	MGRBC Counter under broiler	40
MGRBC (cajones)	MGRBC (drawers)	41
MGRBC opciones	MGRBC options	42

<b>Bajo mostrador Gastronorm y bajo cocina 1/1 PLUS line</b>		<b>43</b>
--	--	-----------

## Muebles neutros Elements without refrigeration

### 300-600-700 series

MNC Mueble cafetera	MNC Coffee counter	49
MNE/MNEE Estanterías	MNE/MNES Shelves	51
MNES Estanterías sobre mueble	MNES Estanterías sobre mueble	52
MNT Mesas de trabajo	MNT Working tables	53

### Fast food

#### Mesa fría pizza 600-700-800 series

MPR Mesa fría pizza	MPR Pizza counter	61
MPR Mesa fría pizza (cajones)	MPR Pizza counter (drawers)	64
MPR Mesa fría pizza (opciones)	MPR Pizza counter (options)	65

<b>Mesa pizza fría PLUS line</b>		<b>66</b>
----------------------------------	--	-----------



## Fast food

### Mesa fría ensalada 600-700 series

MER Mesa fría ensalada	MER Salad prep refrigerator	69
MER Mesa fría ensalada (cajones)	MER Salad prep refrigerator (drawers)	71
MER Mesa fría ensalada (opciones)	MER Salad prep refrigerator (options)	72
MERT encimera abierta	MERT open worktop	73
MERT encimera abierta (opciones)	MERT open worktop (options)	74
MERV con vitrina cristal	MERV with glass display case	75
MERV con vitrina cristal (opciones)	MERV with glass display case (options)	76

<b>Mesa fría ensalada PLUS line</b>		<b>77</b>
-------------------------------------	--	-----------

## Armarios Cabinets

### Snack series

ARS refrigerado	ARS refrigerator	82
ARS refrigerado puertas divididas	ARS refrigerator divided doors	83
ARS refrigerado puertas cristal	ARS refrigerator with glass doors	84
ACS congelación	ARC freezer	85
ARCS refrigeración y congelación	ARCS refrigerator and freezer	86
ARS/ACS opciones	ARS/ARC options	87

<b>Armario snack series PLUS line</b>		<b>88</b>
---------------------------------------	--	-----------

### Armarios Gastronorm

#### GN1/1 series

ARG refrigerado	ARG refrigerator	92
ARG refrigerado puertas divididas	ARG refrigerator divided doors	93
ARG refrigerado puertas cristal	ARG refrigerator with glass doors	94
ACG congelación	ACG freezer	95
ARCG refrigeración y congelación	ARCG refrigerator and freezer	96
ARG/ARC opciones	ARG/ARC options	97

#### GN2/1 series

ARG refrigerado	ARG refrigerator	99
ARG refrigerado puertas divididas	ARG refrigerator divided doors	100
ARG refrigerado puertas cristal	ARG refrigerator with glass doors	101
ACG congelación	ACG freezer	102
ARCG refrigeración y congelación	ARCG refrigerator and freezer	103
ARG/ARC opciones	ARG/ARC options	104

<b>Armarios GN series PLUS line</b>		<b>105</b>
-------------------------------------	--	------------

## Cocktelería Cocktail bar

### 700 series

MNK cocktelería neutra	MNK cocktail bar without refrigeration	110
MRK cocktelería con refrigeración	MRK cocktail bar refrigerator	111
MNK-MRK opciones	MNK-MRK options	112

<b>Cocktelería PLUS line</b>		<b>113</b>
------------------------------	--	------------



# Mesas Undercounters

# Mesas Undercounters

## índice index

### Frentemostrador 600 series

MFR Frentemostrador refrigerado	MFR Back bar counter refrigerator	13
MFRC (puertas cristal)	MFR (glass door)	14
MFRGR (equipo remoto)	MFRGR (remote group)	15
MFR + cajones	MFR +drawers	16
MFR opciones	MFR options	17
<b>Frentemostrador PLUS line</b>		<b>18</b>

### Bajo mostrador 600 series

MBR/MBRF Mesa baja refrigerada	MBR Undercounter refrigerator	22
MBRC (puertas cristal)	MBRC (glass door)	23
MBRGR (equipo remoto)	MBRGR (remote group)	24
MBR + cajones	MBR + drawers	25
MBC (congelación)	MBC (freezer)	26
MBCGR (equipo remoto congelación)	MBCGR (freezer remote group)	27
MBR/MBC opciones	MBR/MBC options	28
<b>Bajo mostrador PLUS line</b>		<b>29</b>

### 700 series GN 1/1

MGR/MGRF Mesa gastronorm refr	MGR Gastro undercounter refrigerator	33
MGRC (puertas cristal)	MGRC (glass door)	34
MGRGR (equipo remoto)	MGRGR (remote group)	35
MGR + cajones	MGR + drawers	36
MGC (congelación)	MGC (freezer)	37
MGCGR (equipo remoto congelación)	MGCGR (freezer remote group)	38
MGR/MGC opciones	MGR/MGC options	39

### 700 series GN 1/1 bajo cocina

MGRBC Mesa gastronorm BC	MGRBC Counter under broiler	40
MGRBC (cajones)	MGRBC (drawers)	41
MGRBC opciones	MGRBC options	42
<b>Bajo mostrador Gastronorm y bajo cocina PLUS line</b>		<b>43</b>



índice index

MFR

13-14



MFRC (puertas cristal)

MFRC (glass doors)

15-16



MFRGR (grupo remoto)

MFRGR (remote group)

17-18



MFR + cajones

MFR + drawers

19-20



MFR opciones

MFR options

21-22



Frentemostrador PLUS line

PLUS line back-bar counter

21-22









modelo · model  
MFR2500

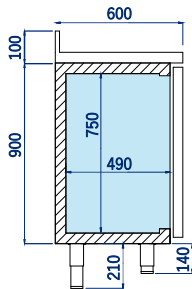

ficha técnica y modelos · technical sheet and models



	 Consumo (W) Consumption (W)	 Potencia frigorífica (W) Cooling capacity (W)	 Rango de temperatura (°C) Temperature range	 Estantes Shelves	 Capacidad (L) Capacity (L)	 Refrigerante Recomendado Recommended Refrigerant	 CEE ECC
MFR1500	235	502	-2 / +8	4	325	R290	B
MFR2000	238	502	-2 / +8	6	504	R290	B
MFR2500	340	845	-2 / +8	8	684	R290	C



1498x600x1040 mm	1990x600x1040 mm	2482x600x1040 mm
MFR1500	MFR2000	MFR2500
2.581 €	3.148 €	3.662 €

modelo · model  
MFR2000C

dos cajones neutros (versión estándar)  
two neutral drawers (standard version)



ficha técnica y modelos · technical sheet and models





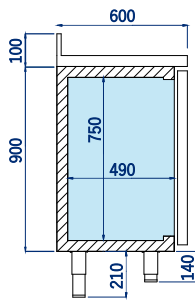

	Consumo (W)	Potencia frigorífica (W)	Rango de temperatura (°C)	Estantes	Capacidad (L)	Refrigerante Recomendado	CEE
	Consumption (W)	Cooling capacity (W)	Temperature range	Shelves	Capacity (L)	Recommended Refrigerant	ECC
MFR1500C	247	502	-2 / +8	4	325	R290	B
MFR2000C	255	502	-2 / +8	6	504	R290	B
MFR2500C	363	845	-2 / +8	8	684	R290	C

1498x600x1040 mm	1990x600x1040 mm	2482x600x1040 mm
MFR1500C	MFR2000C	MFR2500C
2.999 €	3.774 €	4.486 €

modelo · model  
**MFRGR2200C**



ficha técnica y modelos · technical sheet and models

	 Potencia frigorífica (W) Cooling capacity (W)	 Rango de temperatura (°C) Temperature range	 Estantes Shelves	 Capacidad (L) Capacity (L)	 Refrigerante Recomendado Recommended Refrigerant	 CEE ECC
MFRGR1200	300	-2 / +8	4	325	R290	B
MFRGR1700	356	-2 / +8	6	504	R290	B
MFRGR2200	485	-2 / +8	8	684	R290	C
MFRGR1200C	300	-2 / +8	4	325	R290	B
MFRGR1700C	356	-2 / +8	6	504	R290	B
MFRGR2200C	485	-2 / +8	8	684	R290	C



1238x600x1040 mm		1733x600x1040 mm		2223x600x1040 mm	
MFRGR1200	MFRGR1200C	MFRGR1700	MFRGR1700C	MFRGR2200	MFRGR2200C
1.972 €	2.393 €	2.440 €	3.070 €	2.868 €	3.677 €

modelo · model  
MFR2000 + cajones

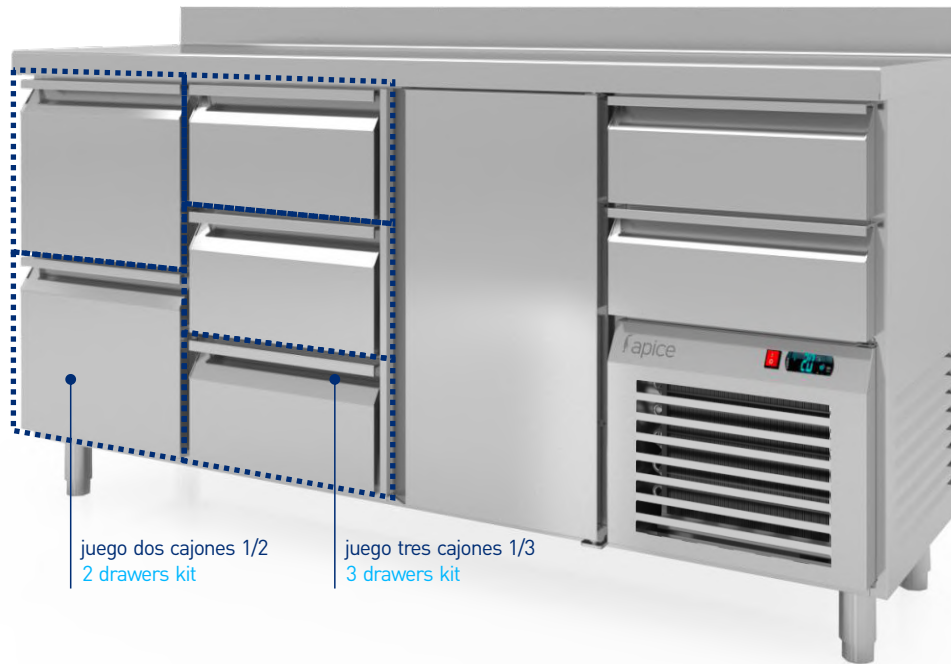

ficha técnica y modelos · technical sheet and models

	Consumo (W) Consumption (W)	Potencia frigorífica (W) Cooling capacity (W)	Rango de temperatura (°C) Temperature range	Estantes Shelves	Capacidad (L) Capacity (L)	Refrigerante Recomendado Recommended Refrigerant	CEE ECC
MFR1500 cajones (drawers)	235	502	-2 / +8	4	325	R290	B
MFR2000 cajones (drawers)	238	502	-2 / +8	6	504	R290	B
MFR2500 cajones (drawers)	340	845	-2 / +8	8	684	R290	C

345x470x298 mm	345x470x164 mm
juego cajones 1/2	juego cajones 1/3
753 €	944 €





listado de opciones y precio · options list and price

RESUMEN OPCIONES · options summary	PRECIO · price
Encimera sin peto · countertop without bib	0 €
Respaldo acero inoxidable · stainless steel back	consultar
Juego 2 cajones · 2 drawers kit	753 €
Juego 3 cajones · 3 drawers kit	944 €
Kit 4 ruedas · kit 4 wheels	148 €
Kit 6 ruedas · kit 6 wheels	223 €
Cajón tolva café · coffee grounds hopper	0 €
Led RGB por puerta · door led RGB	65 €
Unidad equipo remoto · remote group	consultar
Grupo izquierda · group opposite side	76 €
Grupo tropicalizado (43°C) · tropicalized group	consultar
Cerradura (unidad) · lock (unit)	37 €
Cerradura puerta cristal (unidad) lock glass door (unit)	62 €
Parrilla adicional · extra wire shelf	42 €
Juego de guías · slides	40 €
Kit KVF [kit ventilación forzada] · forced ventilation kit	240 €
* en MFR sustituye a cajones neutros/tolva sobre motor · in MFR replaces drawers/hopper on motor	

¿quieres personalizar los acabados de tu producto? bienvenido a nuestra sección HORECA Plus

600 SERIES  
PLUS

## Frente mostrador PLUS line

Back-bar counter PLUS line





### MFR2000+CAJONES PLUS ① RAL9011 ② Cobre | copper ③ RAL9011



acabados y modelos · finishes and models

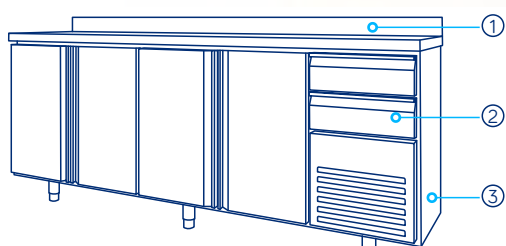

- ① encimera + peto countertop + bib
- ② puertas, cajón y rejilla doors, drawer and grille
- ③ estructura principal principal structure



efecto cobre | latón  
| acero inoxidable |  
carta RAL (consultar)

effects copper | brass  
| stainless steel |  
RAL colour (check)

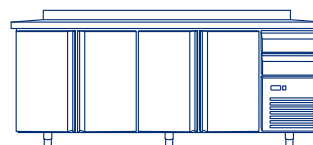
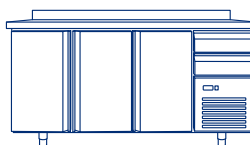
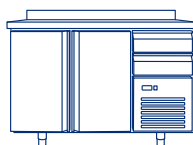

1498x600x1040 mm	1990x600x1040 mm	2482x600x1040 mm
MFR1500+	MFR2000+	MFR2500+
2.839 € (base inox)	3.463 € (base inox)	4.028 € (base inox)

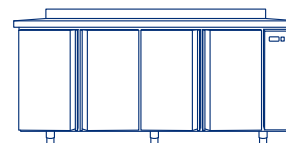
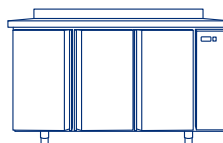
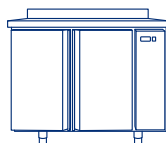

1238x600x1040 mm	1733x600x1040 mm	2223x600x1040 mm
MFRGR1200+	MFRGR1700+	MFRGR2200+
2.169 € (base inox)	2.684 € (base inox)	3.155 € (base inox)

### MFR2000C PLUS ① RAL9010 ② RAL1015 ③ RAL1015



acabados y modelos · finishes and models

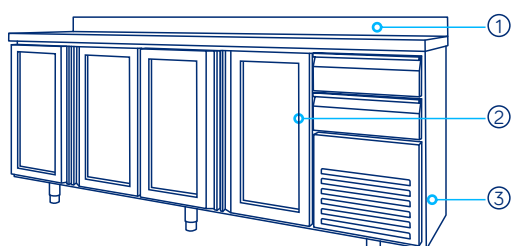

- ① encimera + peto countertop + bib
- ② puertas, cajón y rejilla doors, drawer and grille
- ③ estructura principal principal structure



efecto cobre | latón  
| acero inoxidable |  
carta RAL (consultar)

effects copper | brass  
| stainless steel |  
RAL colour (check)

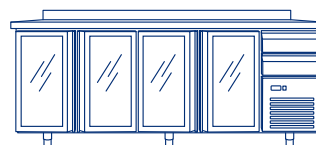
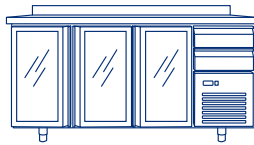
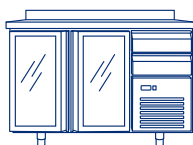

1498x600x1040 mm	1990x600x1040 mm	2482x600x1040 mm
MFR1500C+	MFR2000C+	MFR2500C+
3.299 € (base inox)	4.152 (base inox)	4.935 € (base inox)

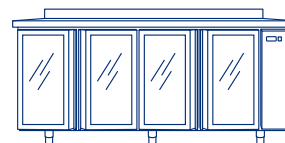
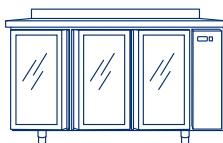
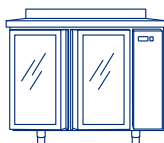

1238x600x1040 mm	1733x600x1040 mm	2223x600x1040 mm
MFRGR1200C+	MFRGR1700C+	MFRGR2200C+
2.632 € (base inox)	3.377 € (base inox)	4.045 € (base inox)



**índice index**

**MBR / MBRF** 25-26



**MBRC (puertas cristal)**  
**MBRC (glass doors)** 27-28



**MBRGR (grupo remoto)**  
**MBRGR (remote group)** 29-30



**MBR + cajones**  
**MBR + drawers** 31-32



**MBC** 33-34



**MBCGR (grupo remoto)**  
**MBCGR (remote group)** 35-36



**MBR y MBC opciones**  
**MBR y MBC options** 37-38



**Bajo mostrador PLUS line**  
**PLUS line undercounter** 21-22



# Bajo mostrador refrigeración (sin/con fregadero)

Undercounter refrigerator (with or without sink)



# 600 SERIES

modelo · model  
**MBR2000F**

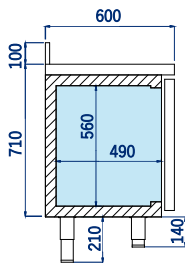

ficha técnica y modelos · technical sheet and models



	 Consumo (W) Consumption (W)	 Potencia frigorífica (W) Cooling capacity (W)	 Rango de temperatura (°C) Temperature range	 Estantes Shelves	 Capacidad (L) Capacity (L)	 Refrigerante Recomendado Recommended Refrigerant	 CEE ECC
MBR1500 / MBR1500F	235	502	-2 / +8	2	245	R290	B
MBR2000 / MBR2000F	238	502	-2 / +8	3	380	R290	B
MBR2500 / MBR2500F	340	845	-2 / +8	4	516	R290	C







1498x600x850 mm F:400x340x200 mm		1990x600x850 mm F:400x340x200 mm		2482x600x850 mm F: 400x340x200 mm	
MBR1500	MBR1500F	MBR2000	MBR2000F	MBR2500	MBR2500F
2.307 €	2.553 €	2.766 €	2.981 €	3.261 €	3.493 €

modelo · model  
MBR2500C

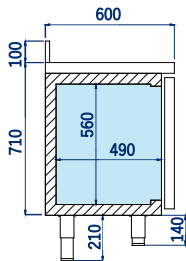

ficha técnica y modelos · technical sheet and models



	 Consumo (W) Consumption (W)	 Potencia frigorífica (W) Cooling capacity (W)	 Rango de temperatura (°C) Temperature range	 Estantes Shelves	 Capacidad (L) Capacity (L)	 Refrigerante Recomendado Recommended Refrigerant	 CEE ECC
MBR1500C	243	502	-2 / +8	2	245	R290	C
MBR2000C	251	502	-2 / +8	3	380	R290	C
MBR2500C	357	845	-2 / +8	4	516	R290	C

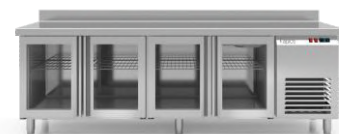

1498x600x850 mm	1990x600x850 mm	2482x600x850 mm
MBR1500C	MBR2000C	MBR2500C
2.650 €	3.273 €	3.936 €



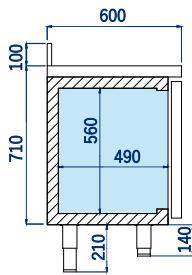

**Bajo mostrador refrigeración grupo remoto (con/sin puertas cristal)**  
Undercounter refrigerator (with or without glass door)

600 SERIES

modelo · model  
**MBRGR1200**



ficha técnica y modelos · technical sheet and models

	 Potencia frigorífica (W) Cooling capacity (W)	 Rango de temperatura (°C) Temperature range	 Estantes Shelves	 Capacidad (L) Capacity (L)	 Refrigerante Recomendado Recommended Refrigerant	 CEE ECC
MBRGR1200	300	-2 / +8	2	245	R290	B
MBRGR1700	356	-2 / +8	3	380	R290	B
MBRGR2200	485	-2 / +8	4	516	R290	C
MBRGR1200C	300	-2 / +8	2	245	R290	C
MBRGR1700C	356	-2 / +8	3	380	R290	C
MBRGR2200C	485	-2 / +8	4	516	R290	C

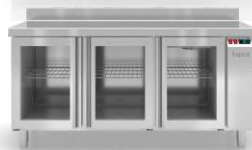

1238x600x850 mm		1733x600x850 mm		2223x600x850 mm	
MBRGR1200	MBRGR1200C	MBRGR1700	MBRGR1700C	MBRGR2200	MBRGR2200C
1.867 €	2.205 €	2.309 €	2.817 €	2.639 €	3.301 €



modelo · model  
MBR2000 + cajones



juego dos cajones 1/2  
2 drawers kit

juego tres cajones 1/3  
3 drawers kit

ficha técnica y modelos · technical sheet and models

	Consumo (W) Consumption (W)	Potencia frigorífica (W) Cooling capacity (W)	Rango de temperatura (°C) Temperature range	Estantes Shelves	Capacidad (L) Capacity (L)	Refrigerante Recomendado Recommended Refrigerant	CEE ECC
MBR1500 cajones (drawers)	235	502	-2 / +8	2	245	R290	B
MBR2000 cajones (drawers)	238	502	-2 / +8	3	380	R290	B
MBR2500 cajones (drawers)	340	845	-2 / +8	4	516	R290	C

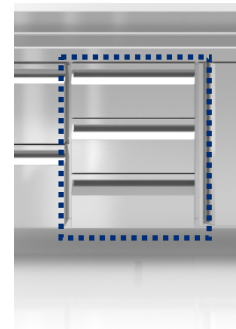
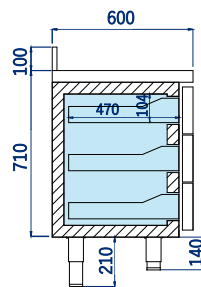
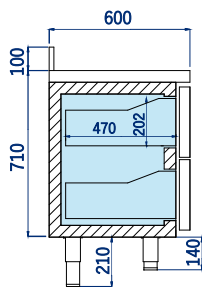

345x470x202 mm	345x470x104 mm
juego cajones 1/2	juego cajones 1/3
481 €	713 €



**Bajo mostrador congelación (con/sin puertas de cristal)**  
Undercounter freezer (with or without glass door)





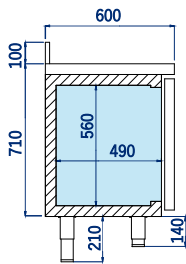

600 SERIES

modelo · model  
**MBC1500**



ficha técnica y modelos · technical sheet and models



	 Consumo (W) Consumption (W)	 Potencia frigorífica (W) Cooling capacity (W)	 Rango de temperatura (°C) Temperature range	 Estantes Shelves	 Capacidad (L) Capacity (L)	 Refrigerante Recomendado Recommended Refrigerant	 CEE ECC
MBC1500	535	606	-20 / -15	2	245	R290	D
MBC2000	556	606	-20 / -15	3	380	R290	E
MBC1500C	544	606	-20 / -15	2	245	R290	D
MBC2000C	548	606	-20 / -15	3	380	R290	E

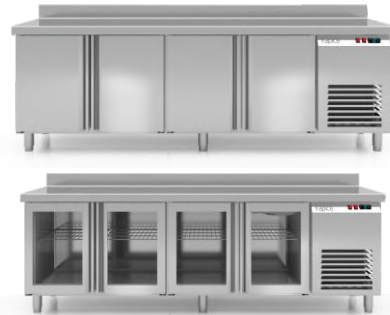

1498x600x850 mm		1990x600x850 mm	
MBC1500	MBC1500C	MBC2000	MBC2000C
2.954 €	3.291 €	3.378 €	3.904 €

**Bajo mostrador congelación grupo remoto (con/sin puertas de cristal)**  
 Remote undercounter freezer (with or without glass door)

600 SERIES

modelo · model  
**MBCGR1700**



ficha técnica y modelos · technical sheet and models

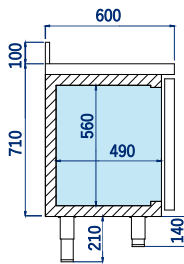

Potencia  
 frigorífica (W)  
 Cooling  
 capacity (W)



Rango de  
 temperatura (°C)  
 Temperature  
 range



Estantes  
 Shelves



Capacidad  
 (L)  
 Capacity (L)



Refrigerante  
 Recomendado  
 Recommended  
 Refrigerant



CEE  
 ECC

	Potencia frigorífica (W) Cooling capacity (W)	Rango de temperatura (°C) Temperature range	Estantes Shelves	Capacidad (L) Capacity (L)	Refrigerante Recomendado Recommended Refrigerant	CEE ECC
MBCGR1200	353	-20 / -15	2	245	R290	D
MBCGR1700	452	-20 / -15	3	380	R290	E
MBCGR1200C	353	-20 / -15	2	245	R290	D
MBCGR1700C	452	-20 / -15	3	380	R290	E

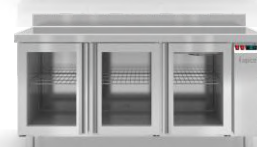

1238x600x850 mm		1733x600x850 mm	
MBCGR1200	MBCGR1200C	MBCGR1700	MBCGR1700C
2.057 €	2.450 €	2.521 €	3.158 €



listado de opciones y precio · options list and price

RESUMEN OPCIONES · options summary	PRECIO · price
Encimera sin peto · countertop without bib	0 €
Respaldo acero inoxidable · stainless steel back	consultar
Juego 2 cajones · 2 drawers kit	481 €
Juego 3 cajones · 3 drawers kit	713 €
Kit 4 ruedas · kit 4 wheels	148 €
Kit 6 ruedas · kit 6 wheels	223 €
Led RGB por puerta · door led RGB	65 €
Unidad equipo remoto · remote group	consultar
Grupo izquierda · group opposite side	76 €
Grupo tropicalizado (43°C) · tropicalized group	consultar
Cerradura (unidad) · lock (unit)	37 €
Cerradura puerta cristal (unidad) lock glass door (unit)	62 €
Parrilla adicional · extra wire shelf	42 €
Juego de guías · slides	40 €
Kit KVF (kit ventilación forzada) · forced ventilation kit	240 €



¿quieres personalizar los acabados de tu producto? bienvenido a nuestra sección HORECA Plus

600 SERIES  
PLUS

## Bajo mostrador PLUS line Undercounter counter PLUS line



# MBR|MBC|MBRGR|MBCGR

Bajo mostrador refrigeración | congelación | remoto  
Back-bar counter refrigerator | freezer | remote back-bar

## 600 SERIES PLUS

### MBR1500 PLUS

① RAL5020 ② RAL5020 ③ RAL5020



acabados y modelos · finishes and models



- ① encimera + peto countertop + bib
- ② puertas, cajón y rejilla doors, drawer and grille
- ③ estructura principal principal structure



efecto cobre | latón  
| acero inoxidable |  
carta RAL (consultar)

effects copper | brass  
| stainless steel |  
RAL colour (check)

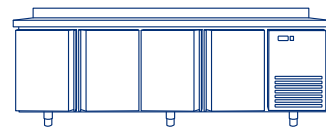
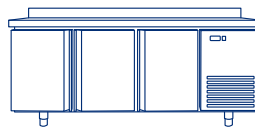
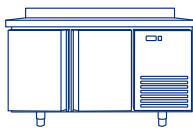

1498x600x850 mm		1990x600x850 mm		2482x600x850 mm	
MBR1500+	MBC1500+	MBR2000+	MBC2000+	MBR2500+	
2.538 € (base inox)	3.250 € (base inox)	3.043 € (base inox)	3.716 € (base inox)	3.587 € (base inox)	

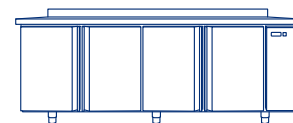
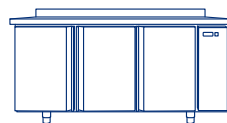
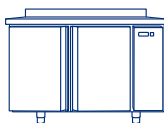

1238x600x850 mm		1733x600x850 mm		2223x600x850 mm	
MBRGR1200+	MBCGR1200+	MBRGR1700+	MBCGR1700+	MBRGR2200+	
2.053 € (base inox)	2.263 € (base inox)	2.540 € (base inox)	2.773 € (base inox)	2.903 € (base inox)	



### MBR2500C PLUS ① RAL9010 ② Latón | brass ③ Latón | brass



#### acabados y modelos · finishes and models

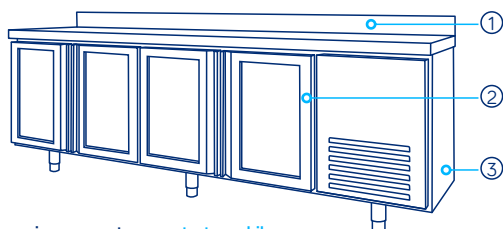

- ① encimera + peto countertop + bib
- ② puertas, cajón y rejilla doors, drawer and grille
- ③ estructura principal principal structure



efecto cobre | latón  
| acero inoxidable |  
carta RAL (consultar)

effects copper | brass  
| stainless steel |  
RAL colour (check)

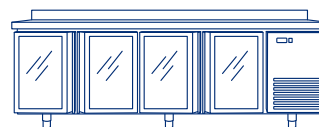
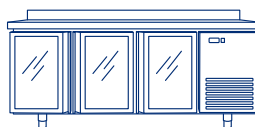

1498x600x850 mm		1990x600x850 mm		2482x600x850 mm	
MBR1500C+	MBC1500C+	MBR2000C+	MBC2000C+	MBR2500C+	
2.915 € (base inox)	3.620 € (base inox)	3.601 € (base inox)	4.295 € (base inox)	4.330 € (base inox)	

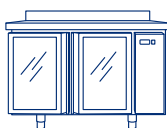

1238x600x850 mm		1733x600x850 mm		2223x600x850 mm	
MBRGR1200C+	MBCGR1200C+	MBRGR1700C+	MBCGR1700C+	MBRGR2200C+	
2.426 € (base inox)	2.695 € (base inox)	3.099 € (base inox)	3.474 € (base inox)	3.631 € (base inox)	

**índice index**

**MGR / MGRF** 41-42

**MGRC (puertas cristal)**  
**MGRC (glass doors)** 43-44

**MGRGR (grupo remoto)**  
**MGRGR (remote group)** 45-46

**MGR + cajones**  
**MGR + drawers** 47-48

**MGC** 49-50

**MGCGR (grupo remoto)**  
**MGCGR (remote group)** 51-52

**MGR y MGC opciones**  
**MGR y MGC options** 53-54

**MGRBC Mesa gastronorm bajo cocina**  
**MGRBC Counter under counter** 55-56

**MGRBC (cajones)**  
**MGRBC drawers** 57-58

**MGRBC opciones**  
**MGRBC options** 59-60

**Bajo mostrador Gastronorm PLUS line**  
**Gastronorm PLUS line undercounter** 21-22



# Bajo mostrador Gastronorm refrigeración (sin/con fregadero)

Gastronorm undercounter refrigerator (with or without sink)

# 700 SERIES

modelo · model  
**MGR2000**



ficha técnica y modelos · technical sheet and models

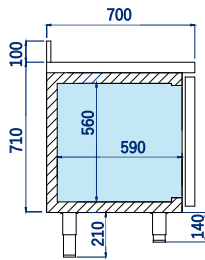

	Consumo (W) Consumption (W)	Potencia frigorífica (W) Cooling capacity (W)	Rango de temperatura (°C) Temperature range	Estantes Shelves	Pares guías Slides sets	Capacidad (L) Capacity (L)	Refrigerante Recomendado Recommended Refrigerant	CEE ECC
MGR1500 / MGR1500F	235	502	-2 / +8	2	4	255	R290	B
MGR2000 / MGR2000F	238	502	-2 / +8	3	6	399	R290	B
MGR2500 / MGR2500F	340	845	-2 / +8	4	8	543	R290	C



1498x700x850 mm F:400x340x200 mm		1990x700x850 mm F:400x340x200 mm		2482x700x850 mm F:400x340x200 mm	
MGR1500	MGR1500F	MGR2000	MGR2000F	MGR2500	MGR2500F
2.665 €	2.934 €	3.152 €	3.435 €	3.729 €	3.975 €

# Bajo mostrador Gastronorm refrigeración puertas cristal

Glass door Gastronorm undercounter refrigerator

# 700 SERIES

modelo · model  
**MGR1500C**



ficha técnica y modelos · technical sheet and models

	Consumo (W)	Potencia frigorífica (W)	Rango de temperatura (°C)	Estantes	Juego guías	Capacidad (L)	Refrigerante Recomendado	CEE
	Consumption (W)	Cooling capacity (W)	Temperature range	Shelves	Slides sets	Capacity (L)	Recommended Refrigerant	ECC
MGR1500C	240	502	-2 / +8	2	4	255	R290	C
MGR2000C	246	502	-2 / +8	3	6	399	R290	C
MGR2500C	352	845	-2 / +8	4	8	543	R290	C



1498x700x850 mm	1990x700x850 mm	2482x700x850 mm
MGR1500C	MGR2000C	MGR2500C
3.043 €	3.670 €	4.415 €



modelo · model  
**MGRGR2200C**

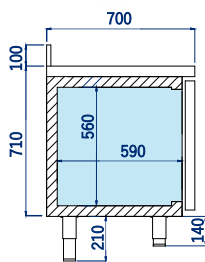

ficha técnica y modelos · technical sheet and models

 Potencia frigorífica (W) Cooling capacity (W)	 Rango de temperatura (°C) Temperature range	 Estantes Shelves	 Pares guías Slides sets	 Capacidad (L) Capacity (L)	 Refrigerante Recomendado Recommended Refrigerant	 CEE ECC	
MGRGR1200	502	-2 / +8	2	4	255	R290	B
MGRGR1700	502	-2 / +8	3	6	399	R290	B
MGRGR2200	845	-2 / +8	4	8	543	R290	C
MGRGR1200C	300	-2 / +8	2	4	255	R290	C
MGRGR1700C	356	-2 / +8	3	6	399	R290	C
MGRGR2200C	485	-2 / +8	4	8	543	R290	C

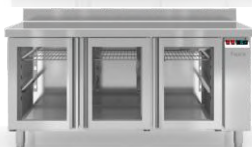
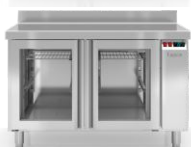

1238x700x850 mm		1733x700x850 mm		2223x700x850 mm	
MGRGR1200	MGRGR1200C	MGRGR1700	MGRGR1700C	MGRGR2200	MGRGR2200C
1.996 €	2.335 €	2.402 €	2.905 €	2.895 €	3.553 €

modelo · model  
MGR2000 + cajones



juego dos cajones 1/2  
2 drawers kit

juego tres cajones 1/3  
3 drawers kit

ficha técnica y modelos · technical sheet and models

	Consumo (W) Consumption (W)	Potencia frigorífica (W) Cooling capacity (W)	Rango de temperatura (°C) Temperature range	Estantes Shelves	Capacidad (L) Capacity (L)	Refrigerante Recomendado Recommended Refrigerant	CEE ECC
MGR1500 cajones (drawers)	235	502	-2 / +8	2	255	R290	B
MGR2000 cajones (drawers)	238	502	-2 / +8	3	399	R290	B
MGR2500 cajones (drawers)	340	845	-2 / +8	4	543	R290	C

345x570x202 mm	345x570x104 mm
juego cajones 1/2	juego cajones 1/3
610 €	797 €

# Bajo mostrador Gastronorm congelación (con/sin puertas de cristal)

Gastronorm undercounter freezer (with or without glass door)





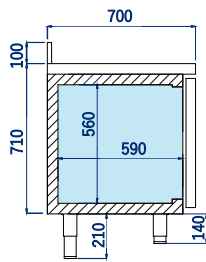

# 700 SERIES

modelo · model  
**MGC2000C**



ficha técnica y modelos · technical sheet and models



							
	Consumo (W)	Potencia frigorífica (W)	Rango de temperatura (°C)	Estantes	Capacidad (L)	Refrigerante Recomendado	CEE
	Consumption (W)	Cooling capacity (W)	Temperature range	Shelves	Capacity (L)	Recommended Refrigerant	ECC
MGC1500	535	606	-20 / -15	2	255	R290	D
MGC2000	556	606	-20 / -15	3	399	R290	D
MGC1500C	540	606	-20 / -15	2	255	R290	D
MGC2000C	544	606	-20 / -15	3	399	R290	D



1498x700x850 mm		1990x700x850 mm	
MGC1500	MGC1500C	MGC2000	MGC2000C
3.476 €	3.872 €	4.072 €	4.615 €

modelo · model  
**MGCGR1200**



ficha técnica y modelos · technical sheet and models

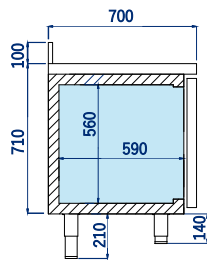

Potencia  
 frigorífica (W)  
 Cooling  
 capacity (W)



Rango de  
 temperatura (°C)  
 Temperature  
 range



Estantes  
 Shelves



Capacidad  
 (L)  
 Capacity (L)



Refrigerante  
 Recomendado  
 Recommended  
 Refrigerant



CEE  
 ECC

	Potencia frigorífica (W) Cooling capacity (W)	Rango de temperatura (°C) Temperature range	Estantes Shelves	Capacidad (L) Capacity (L)	Refrigerante Recomendado Recommended Refrigerant	CEE ECC
MGCGR1200	353	-20 / -15	2	255	R290	D
MGCGR1700	452	-20 / -15	3	399	R290	E
MGCGR1200C	353	-20 / -15	2	255	R290	D
MGCGR1700C	452	-20 / -15	3	399	R290	E

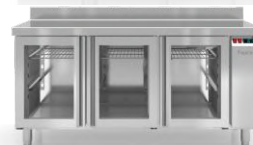

1238x700x850 mm		1733x700x850 mm	
MGCGR1200	MGCGR1200C	MGCGR1700	MGCGR1700C
2.176 €	2.544 €	2.591 €	3.186 €





listado de opciones y precio · options list and price

RESUMEN OPCIONES · options summary	PRECIO · price
Encimera sin peto · countertop without bib	0 €
Respaldo acero inoxidable · stainless steel back	consultar
Juego 2 cajones · 2 drawers kit	610 €
Juego 3 cajones · 3 drawers kit	797 €
Kit 4 ruedas · kit 4 wheels	148 €
Kit 6 ruedas · kit 6 wheels	223 €
Led RGB por puerta · door led RGB	65 €
Unidad equipo remoto · remote group	consultar
Grupo izquierda · group opposite side	76 €
Grupo tropicalizado (43°C) · tropicalized group	consultar
Cerradura (unidad) · lock (unit)	37 €
Cerradura puerta cristal (unidad) lock glass door (unit)	62 €
Parrilla adicional · extra wire shelf	42 €
Juego de guías · slides	40 €
Kit KVF (kit ventilación forzada) · forced ventilation kit	240 €

modelo · model  
**MGR1800BC (3P)**



ficha técnica y modelos · technical sheet and models

	Consumo (W)	Potencia frigorífica (W)	Rango de temperatura (°C)	Estantes	Pares guías	Capacidad (L)	Refrigerante Recomendado	CEE
	Consumption (W)	Cooling capacity (W)	Temperature range	Shelves	Slides sets	Capacity (L)	Recommended Refrigerant	ECC
MGR1400BC (2P)	240	290	-2 / +8	2	2	196	R290	B
MGR1600BC (2P)	262	302	-2 / +8	2	2	222	R290	B
MGR1800BC (3P)	370	302	-2 / +8	3	3	260	R290	B
MGR2000BC (3P)	491	480	-2 / +8	3	3	311	R290	B
MGR2400BC (4P)	491	480	-2 / +8	4	4	357	R290	B

\*todos los modelos incorporan evaporador central

\*all models incorporate a central evaporator

1400x700x600 mm	1600x700x600 mm	1800x700x600 mm	2000x700x600 mm	2400x700x600 mm
MGR1400BC	MGR1600BC	MGR1800BC	MGR2000BC	MGR2400BC
2.507 €	2.708 €	3.033 €	3.276 €	3.646 €

modelo · model  
**MGR1800BC + cajones**

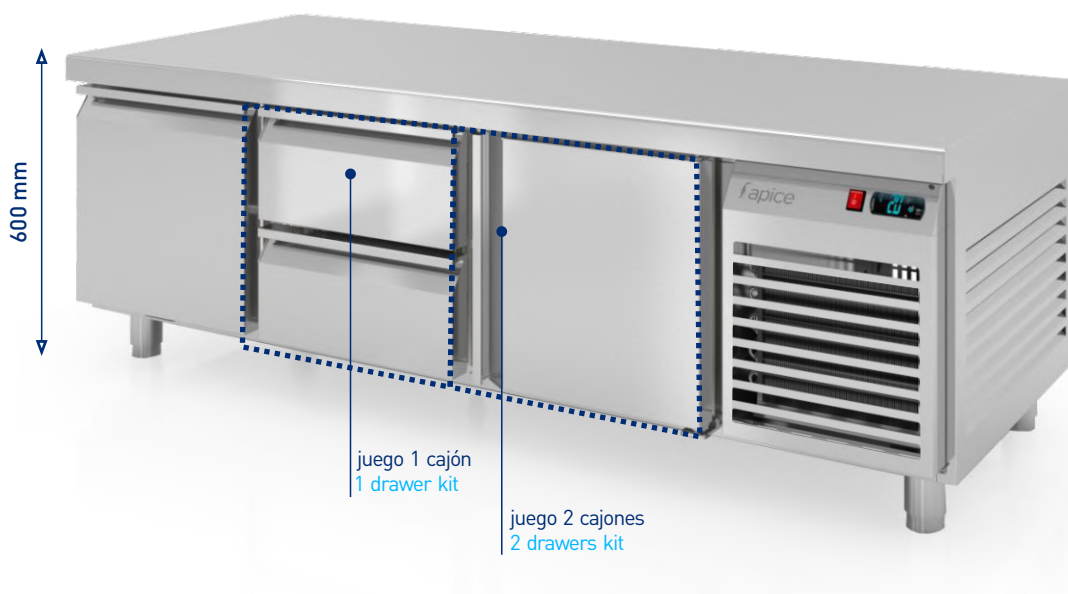

ficha técnica y modelos · technical sheet and models

							
	Consumo (W)	Potencia frigorífica (W)	Rango de temperatura (°C)	Estantes	Capacidad (L)	Refrigerante	CEE
	Consumption (W)	Cooling capacity (W)	Temperature range	Shelves	Capacity (L)	Refrigerant	ECC
MGR1400BC +cajones	240	290	-2 / +8	0	196	R290	B
MGR1600BC +cajones	262	302	-2 / +8	0	222	R290	B
MGR1800BC +cajones	370	302	-2 / +8	0	260	R290	B
MGR2000BC +cajones	491	480	-2 / +8	0	311	R290	B
MGR2400BC +cajones	491	480	-2 / +8	0	357	R290	B

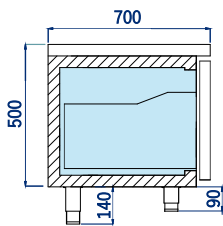
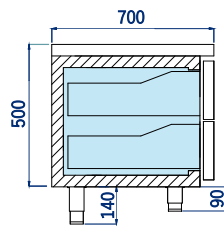
	
juego 1 cajón	juego 2 cajones
340 €	412€

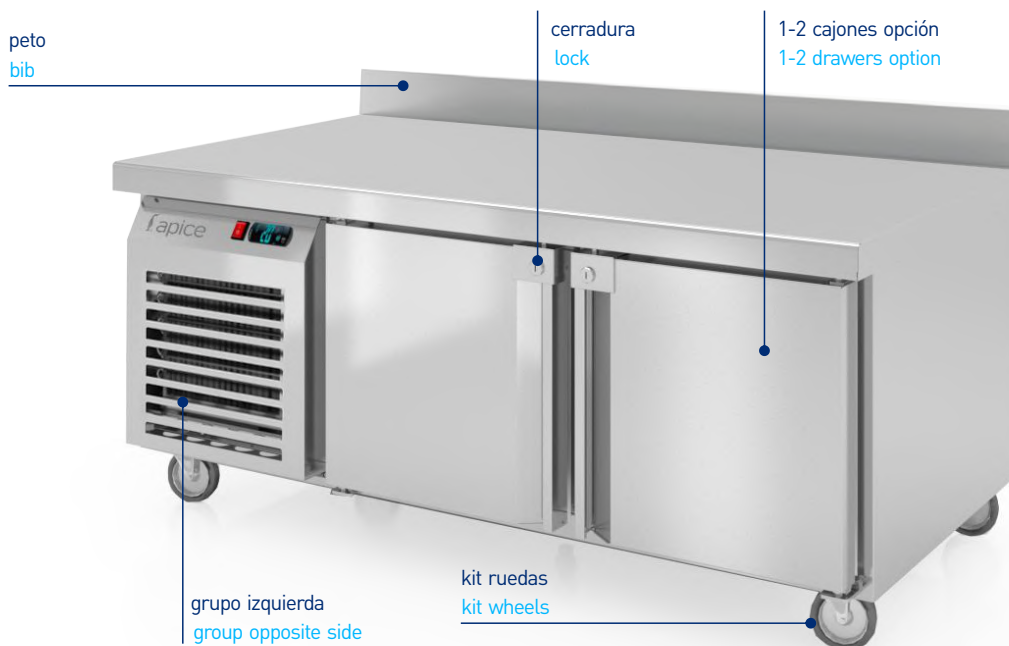

listado de opciones y precio · options list and price

RESUMEN OPCIONES · options summary

PRECIO · price

Encimera sin peto · countertop without bib	0 €
Respaldo acero inoxidable · stainless steel back	consultar
Sin encimera · without countertop	consultar
Juego 1 cajón · 1 drawer kit	340 €
Juego 2 cajones · 2 drawers kit	412 €
Kit 4 ruedas · kit 4 wheels	148 €
Kit 6 ruedas · kit 6 wheels	223 €
Unidad equipo remoto · remote group	consultar
Grupo izquierda · group opposite side	76 €
Grupo tropicalizado (43°C) · tropicalized group	consultar
Cerradura (unidad) · lock (unit)	37 €
Parrilla adicional · extra wire shelf	42 €
Juego de guías · slides	40 €



¿quieres personalizar los acabados de tu producto? bienvenido a nuestra sección HORECA Plus

700 SERIES  
PLUS

## Bajo mostrador Gastronorm PLUS line

Gastronorm undercounter PLUS line



### MGR2500 PLUS

① RAL9010 ② inox + RAL9010 ③ RAL9010



acabados y modelos · finishes and models

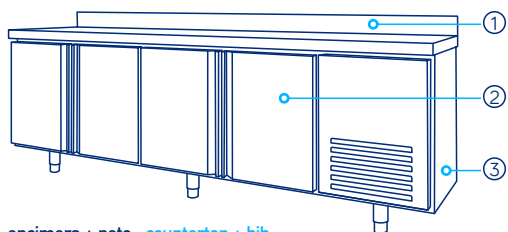

- ① encimera + peto countertop + bib
- ② puertas, cajón y rejilla doors, drawer and grille
- ③ estructura principal principal structure



efecto cobre | latón  
| acero inoxidable |  
carta RAL (consultar)

effects copper | brass  
| stainless steel |  
RAL colour (check)

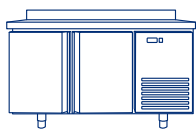

1498x700x850 mm

MGR1500+

2.932 € (base inox)



1990x700x850 mm

MGC1500+

3.824 € (base inox)

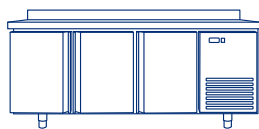

1990x700x850 mm

MGR2000+

3.467 € (base inox)



2482x700x850 mm

MGC2000+

4.479 € (base inox)

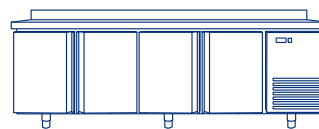

2482x700x850 mm

MGR2500+

4.102 € (base inox)

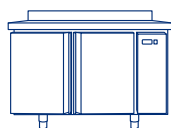

1238x700x850 mm

MBR1500+

2.196 € (base inox)

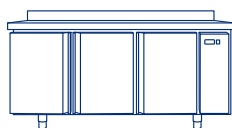

1733x700x850 mm

MBC1500+

2.394 € (base inox)

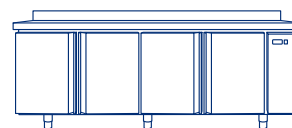

1733x700x850 mm

MBR2000+

2.246 € (base inox)

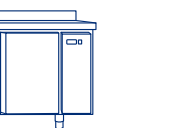

2223x700x850 mm

MBC2000+

2.850 € (base inox)

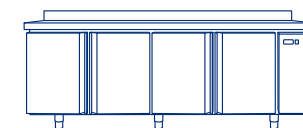

2223x700x850 mm

MBR2500+

3.185 € (base inox)

### MGR1500C PLUS ① RAL6019 ② RAL6019 | RAL6002 ③ RAL6019



#### acabados y modelos · finishes and models

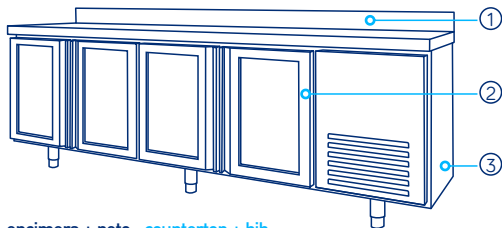

- ① encimera + peto countertop + bib
- ② puertas, cajón y rejilla doors, drawer and grille
- ③ estructura principal principal structure



efecto cobre | latón  
| acero inoxidable |  
carta RAL (consultar)

effects copper | brass  
| stainless steel |  
RAL colour (check)

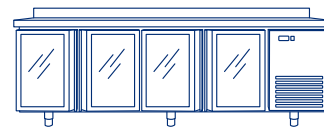
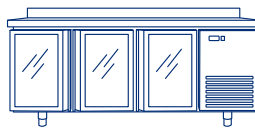
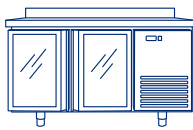

1498x700x850 mm		1990x700x850 mm		2482x700x850 mm	
MGR1500C+	MGC1500C+	MGR2000C+	MGC2000C+	MGR2500C+	
3.347 € (base inox)	4.259 € (base inox)	4.037 € (base inox)	5.077 € (base inox)	4.857 € (base inox)	

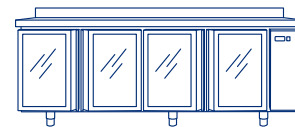
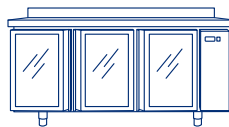
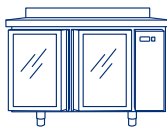

1238x700x850 mm		1733x700x850 mm		2223x700x850 mm	
MGRGR1200C+	MGCGR1200C+	MGRGR1700C+	MGCGR1700C+	MGRGR2200C+	
2.569 € (base inox)	2.798 € (base inox)	3.196 € (base inox)	3.505 € (base inox)	3.908 € (base inox)	



## MGR1800BC PLUS ① Cobre | copper ② Cobre | copper +RAL9011 ③ Cobre | copper



### acabados y modelos · finishes and models

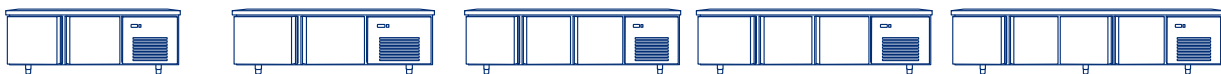
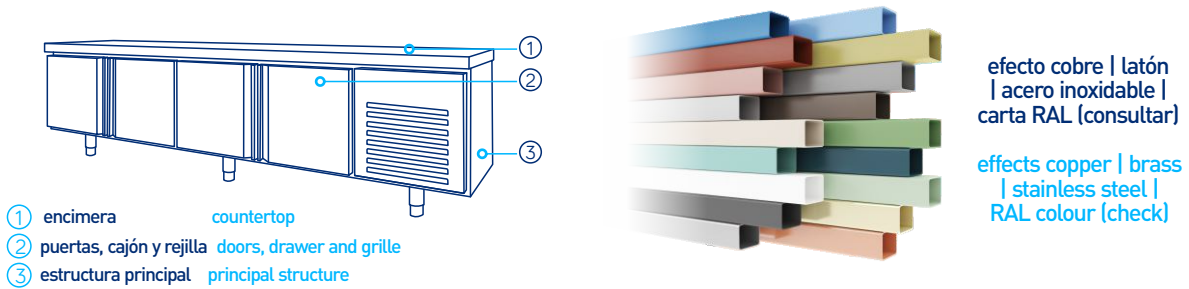

1400x700x600 mm	1600x700x600 mm	1800x700x600 mm	2000x700x600 mm	2400x700x600 mm
MGR1400BC+	MGR1600BC+	MGR1800BC+	MGR2000BC+	MGR2400BC+
2.758 € (base inox)	2.979 € (base inox)	3.336 € (base inox)	3.604 € (base inox)	4.011 € (base inox)





# Muebles neutros Elements without refrigeration

**índice index**

**MNC Mueble cafetera**  
**MNC Coffee counter**

**49-50**



**MNE/MNEE Estanterías 600 series**  
**MNE/MNEE Shelves 600 series**

**51**



**MNE/MNEE Estanterías 300 series**  
**MNE/MNE Shelves 300 series**

**52**



**MNES Estanterías sobre mueble**  
**MNES Supported shelves**

**53**



**MNT Mesas de trabajo**  
**MNT Working tables**

**54**



**Muebles neutros PLUS line**  
**Elements without refrigeration PLUS line**

**55**



modelo · model  
MNC500



modelo · model  
MNC1000



ejemplos de integración · counter integration examples

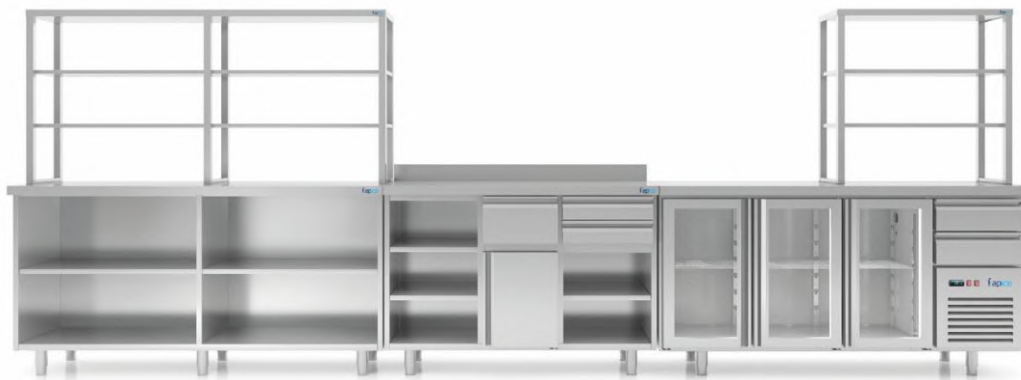
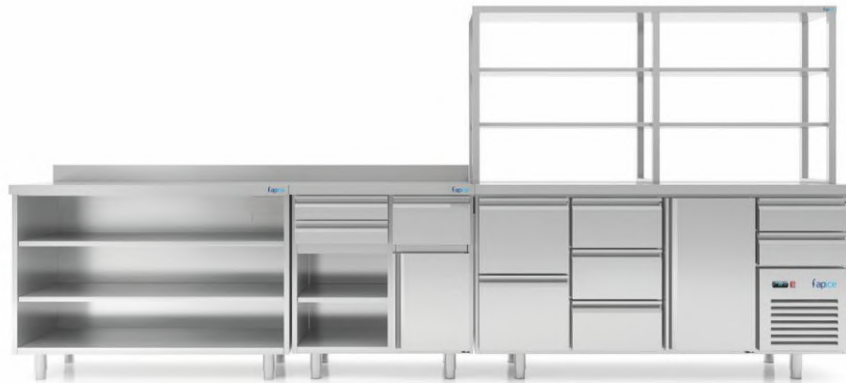

MNES/MNEE/MNC/MFR/MNES series

modelo · model  
**MNC1500**



modelo · model  
**MNC2000**



en baldas consecutivas, opción de eliminar una  
on consecutive shelves, option to remove one

ficha técnica y modelos · technical sheet and models

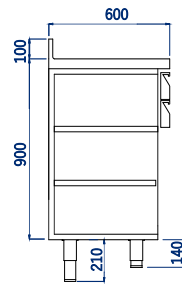
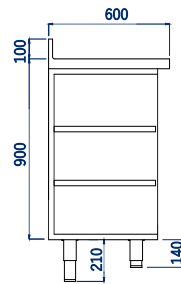
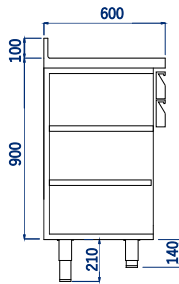
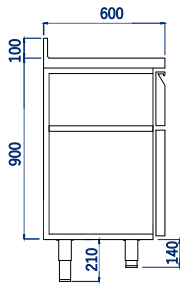

MNC diferentes secciones · MNC diferents sections

opciones · options

encimera sin peto (0 €) countertop without bib (0 €)



498x600x1040 mm	998x600x1040 mm	1498x600x1040 mm	1990x600x1040 mm
MNC500	MNC1000	MNC1500	MNC2000
558 €	982 €	1.210 €	1.368 €



modelo · model  
MNE1500



modelo · model  
MNEE2000



ficha técnica y modelos · technical sheet and models

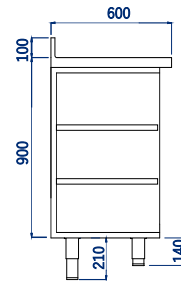
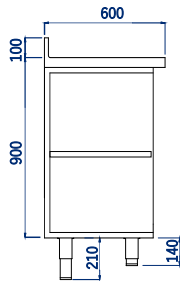

MNE (un estante) MNE (one shelf)

MNEE (dos estantes) MNEE (two shelves)

opciones · options

encimera sin peto (0 €) countertop without bib (0 €)



998x600x1040 mm		1498x600x1040 mm		1990x600x1040 mm	
MNE1000	MNEE1000	MNE1500	MNEE1500	MNE2000	MNEE2000
659 €	761 €	812 €	886 €	1.010 €	1.100 €

modelo · model  
MNE1000R



modelo · model  
MNEE1500R



ficha técnica y modelos · technical sheet and models

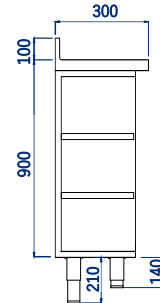
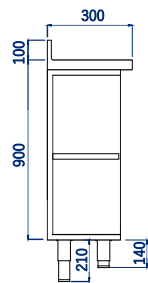

MNE (un estante) MNE (one shelf)

MNEE (dos estantes) MNEE (two shelves)

opciones · options

encimera sin peto (0 €) countertop without bib (0 €)



998x300x1040 mm		1498x300x1040 mm		1990x300x1040 mm	
MNE1000R	MNEE1000R	MNE1500R	MNEE1500R	MNE2000R	MNEE2000R
504 €	645 €	704 €	774 €	903 €	958 €

modelo · model  
**MNES1500**



modelo · model  
**MNES2000**



posibilidad de eliminar baldas  
without shelf option

ejemplo de integración y modelos · integration examples and models



opciones · options

eliminación de balda (0 €) remove one shelf (0 €)

MNES/MNEE/MNC/MFR/MNES series

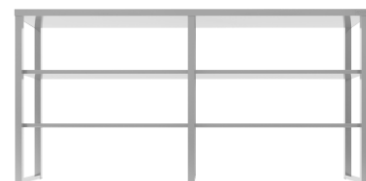

998x300x1180 mm	1498x300x1180 mm	1990x300x1180 mm
MNES1000	MNES1500	MNES2000
944 €	1.074 €	1.392 €

modelo · model  
**MNT1500**

modelo · model  
**MNT2000B**



ficha técnica y modelos · technical sheet and models

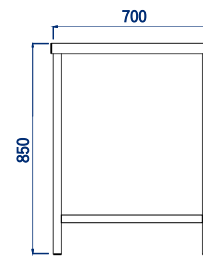
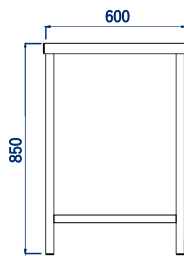

MNT (fondo 600mm) MNT (depth 600mm)

MNTB (fondo 700mm) MNTB (depth 700mm)



998x600x850 mm	998x700x850 mm	1498x600x850 mm	1498x700x850 mm	1990x600x850 mm	1990x700x850 mm
MNT1000	MNT1000B	MNT1500	MNT1500B	MNT2000	MNT2000B
574 €	627 €	717 €	763 €	897 €	957 €



¿quieres personalizar los acabados de tu producto?  
bienvenido a nuestra sección HORECA Plus

300-600-700 SERIES  
PLUS

## Muebles neutros

Elements without refrigeration





### MNC2000 PLUS

① RAL7022 ② RAL1015 ③ RAL7022



#### acabados y modelos · finishes and models

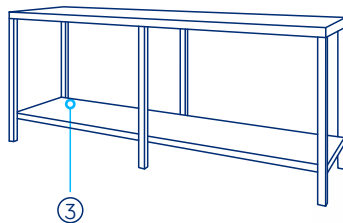
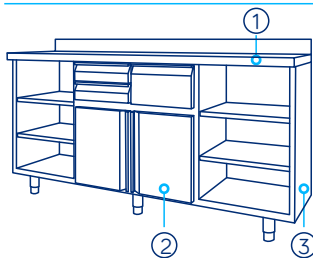

efecto cobre | latón  
| acero inoxidable |  
carta RAL (consultar)

effects copper | brass  
| stainless steel |  
RAL colour (check)

- ① encimera + peto countertop + bib
- ② puertas, cajón y rejilla doors, drawer and grille
- ③ estructura principal y baldas principal structure and shelves

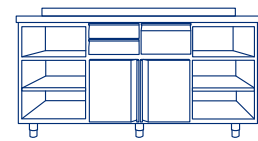
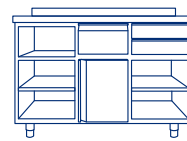
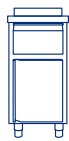

498x600x1040 mm	998x600x1040 mm	1498x600x1040 mm	1990x600x1040 mm
MNC500+	MNC1000+	MNC1500+	MNC2000+
614 € (base inox)	1.080 € (base inox)	1.331 € (base inox)	1.505 € (base inox)

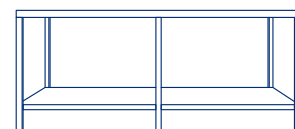
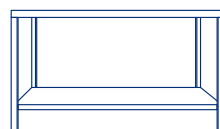
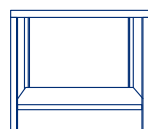

998x600-700x850 mm		1198x600-700x850 mm		1990x600-700x850 mm	
MNT1000+	MNT1000B+	MNT1500+	MNT1500B+	MNT2000+	MNT2000B+
632 € (base inox)	690 € (base inox)	789 € (base inox)	839 € (base inox)	987 € (base inox)	1.053 € (base inox)

### MNE1500 PLUS MNES1500 PLUS

- ① RAL6019
- ② RAL6019
- ③ RAL6019



acabados y modelos · finishes and models

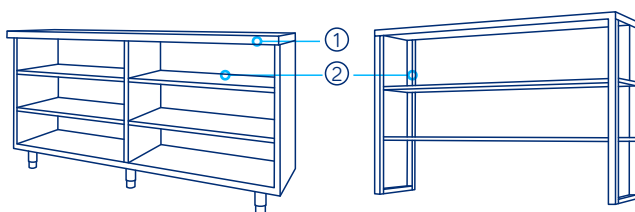

- ① encimera + peto countertop + bib
- ② estructura principal principal structure



efecto cobre | latón  
| acero inoxidable |  
carta RAL (consultar)

effects copper | brass  
| stainless steel |  
RAL colour (check)

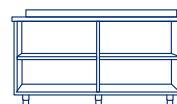
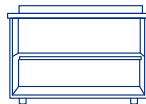

998x300-600x1040 mm		1498x300-600x1040 mm		1990x300-600x1040 mm	
MNE1000+	MNE1000R+	MNE1500+	MNE1500R+	MNE2000+	MNE2000R+
725 € (base inox)	554 € (base inox)	893 € (base inox)	774 € (base inox)	1.111 € (base inox)	993 € (base inox)

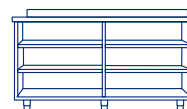

998x300-600x1040 mm		1498x300-600x1040 mm		1990x300-600x1040 mm	
MNEE1000+	MNEE1000R+	MNEE1500	MNEE1500R+	MNEE2000+	MNEE2500R+
837 € (base inox)	710 € (base inox)	975 € (base inox)	852 € (base inox)	1.210 € (base inox)	1.054 € (base inox)

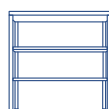

998x300x1180 mm		1498x300x1180 mm		1990x300x1180 mm	
MNES1000+		MNES1500+		MNES2000+	
1.039 € (base inox)		1.182 € (base inox)		1.531 € (base inox)	



# Fast food



# Fast food

## índice index

### Mesa fría pizza 600-700-800 series

<b>MPR Mesa fría pizza</b>	<b>MPR Pizza counter</b>	<b>61</b>
<b>MPR Mesa fría pizza (cajones)</b>	<b>MPR Pizza counter (drawers)</b>	<b>64</b>
<b>MPR Mesa fría pizza (opciones)</b>	<b>MPR Pizza counter (options)</b>	<b>65</b>
<b>Mesa pizza fría PLUS line</b>		<b>66</b>

### Mesa fría ensalada 600-700 series

<b>MER Mesa fría ensalada</b>	<b>MER Salad prep refrigerator</b>	<b>69</b>
<b>MER Mesa fría ensalada (cajones)</b>	<b>MER Salad prep refrigerator (drawers)</b>	<b>71</b>
<b>MER Mesa fría ensalada (opciones)</b>	<b>MER Salad prep refrigerator (options)</b>	<b>72</b>
<b>MERT encimera abierta</b>	<b>MERT open worktop</b>	<b>73</b>
<b>MERT encimera abierta (opciones)</b>	<b>MERT open worktop (options)</b>	<b>74</b>
<b>MERV con vitrina cristal</b>	<b>MERV with glass display case</b>	<b>75</b>
<b>MERV con vitrina cristal (opciones)</b>	<b>MERV with glass display case (options)</b>	<b>76</b>
<b>Mesa fría ensalada PLUS line</b>		<b>77</b>

## índice index

### 600-700-800 series

**MPR Mesa fría pizza**

**MPR Pizza counter**

**61**



**MPR Mesa fría pizza (cajones)**

**MPR Pizza counter (drawers)**

**64**



**MPR Mesa fría pizza (opciones)**

**MPR Pizza counter (options)**

**65**



**Mesa pizza fría PLUS line**

**Pizza counter PLUS line**

**66**



modelo · model  
MPR2000-60

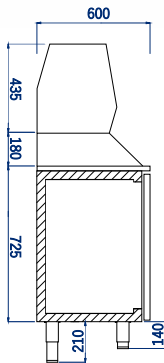

ficha técnica y modelos · technical sheet and models

	 Consumo (W) Consumption (W)	 Potencia frigorífica (W) Cooling capacity (W)	 Rango de temperatura (°C) Temperature range	 Estantes Shelves	 Capacidad (L) Capacity (L)	 Capacidad (GN1/4) Capacity (GN1/4)	 Refrigerante Refrigerant
MPR1500-60	207	285	0 / +8	2	252	6	R290
MPR2000-60	222	294	0 / +8	3	377	9	R290
MPR2500-60	402	718	0 / +8	4	523	12	R290



1498x600x1480 mm



1990x600x1480 mm



2482x600x1480 mm

\*el precio incluye vitrina de ingredientes. No incluye cubetas GN  
\*topping unit included in price. GN containers NOT included in price

MPR1500-60	MPR2000-60	MPR2500-60
3.814 €	4.390 €	5.141 €

modelo · model  
MPR2500-70

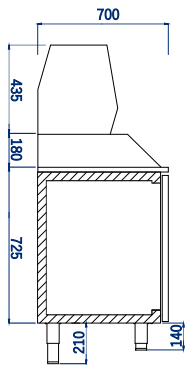

ficha técnica y modelos · technical sheet and models

	 Consumo (W) Consumption (W)	 Potencia frigorífica (W) Cooling capacity (W)	 Rango de temperatura (°C) Temperature range	 Estantes Shelves	 Pares guías Slides sets	 Capacidad (L) Capacity (L)	 Capacidad (GN1/4) Capacity (GN1/4)	 Refrigerante Recomendado Recommended Refrigerant
MPR1500-70	207	285	0 / +8	2	4	282	6	R290
MPR2000-70	222	294	0 / +8	3	6	407	9	R290
MPR2500-70	402	718	0 / +8	4	8	553	12	R290



1498x700x1480 mm



1990x700x1480 mm



2482x700x1480 mm

\*el precio incluye vitrina de ingredientes. No incluye cubetas GN  
\*topping unit included in price. GN containers NOT included in price







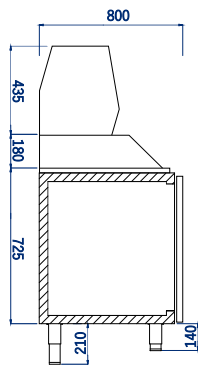

MPR1500-70	MPR2000-70	MPR2500-70
4.017 €	4.808 €	5.417 €



modelo · model  
MPR1500-80



ficha técnica y modelos · technical sheet and models

	 Consumo (W) Consumption (W)	 Potencia frigorífica (W) Cooling capacity (W)	 Rango de temperatura (°C) Temperature range	 Cajas 40x60 Containers	 Pares guías Slides sets	 Capacidad (L) Capacity (L)	 Capacidad (GN1/4) Capacity (GN1/4)	 Refrigerante Recomendado Recommended Refrigerant
MPR1500-80	207	285	0 / +8	0	9	342	6	R290
MPR2000-80	222	294	0 / +8	0	14	511	9	R290
MPR2500-80	402	718	0 / +8	0	19	698	12	R290



1498x800x1480 mm



1990x800x1480 mm



2482x800x1480 mm

\*el precio incluye vitrina de ingredientes. No incluye cubetas GN  
\*topping unit included in price. GN containers NOT included in price

MPR1500-80	MPR2000-80	MPR2500-80
4.444 €	5.357 €	5.739 €

modelo · model  
MPR2500 cajones



kit de 2/3/4 cajones opcionales  
2/3/4 optional drawers kit

ficha técnica y modelos · technical sheet and models

							
	Consumo (W) Consumption (W)	Potencia frigorífica (W) Cooling capacity (W)	Rango de temperatura (°C) Temperature range	Estantes Shelves	Capacidad (L) Capacity (L)	Capacidad (GN1/4) Capacity (GN1/4)	Refrigerante Refrigerant
MPR1500-60	207	285	0 / +8	2	252	6	R290
MPR2000-60	222	294	0 / +8	3	377	9	R290
MPR2500-60	402	718	0 / +8	4	523	12	R290
MPR1500-70	207	285	0 / +8	2	282	6	R290
MPR2000-70	222	294	0 / +8	3	407	9	R290
MPR2500-70	402	718	0 / +8	4	553	12	R290
MPR1500-80	207	285	0 / +8	2	342	6	R290
MPR2000-80	222	294	0 / +8	3	511	9	R290
MPR2500-80	402	718	0 / +8	4	698	12	R290

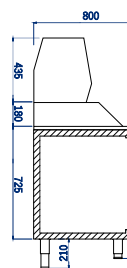
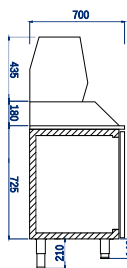
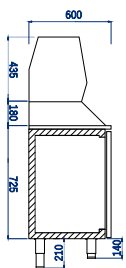

2 cajones kit 2 drawers kit

667 €

3 cajones kit 3 drawers kit

905 €

4 cajones kit 4 drawers kit

consultar

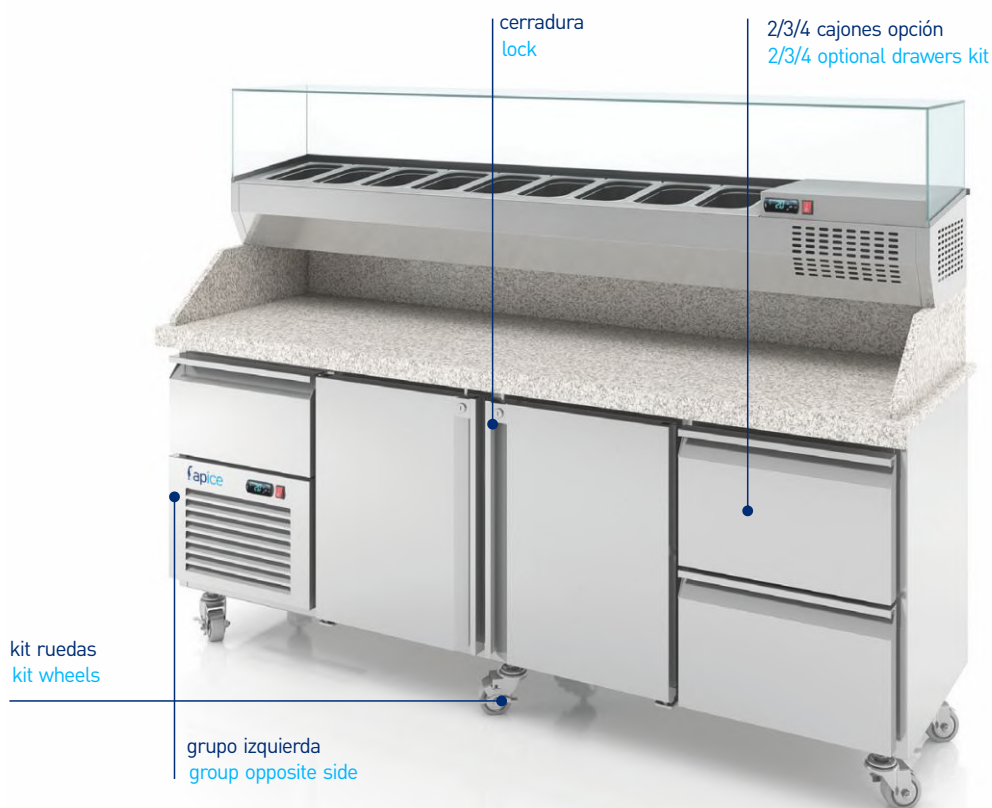

		
MPR1500-60·MPR1500-70·MPR1500-80	MPR2000-60·MPR2000-70·MPR2000-80	MPR2500-60·MPR2500-70·MPR2500-80
6x GN1/4-150	9x GN1/4-150	12x GN1/4-150
		

RESUMEN OPCIONES · options summary	PRECIO · price
Encimera granito · granite worktop	consultar
Respaldo acero inoxidable · stainless steel back	consultar
Juego 2 cajones · 2 drawers kit	667 €
Juego 3 cajones · 3 drawers kit	905 €
Juego 4 cajones · 4 drawers kit	consultar
Kit 4 ruedas · kit 4 wheels	148 €
Kit 6 ruedas · kit 6 wheels	223 €
Grupo izquierda · group opposite side	76 €
Cerradura (unidad) · lock (unit)	37 €
Parrilla adicional · extra wire shelf	42 €
Juego de guías · slides	40 €
Kit KVF (kit ventilación forzada) · forced ventilation kit	240 €

\* en MPR sustituye a cajones neutros/tolva sobre motor · in MFR replaces drawers/hopper on motor



¿quieres personalizar los acabados de tu producto?  
bienvenido a nuestra sección HORECA Plus

600-700-800 SERIES  
PLUS

# Mesa pizza fría PLUS line

## Pizza counter PLUS line

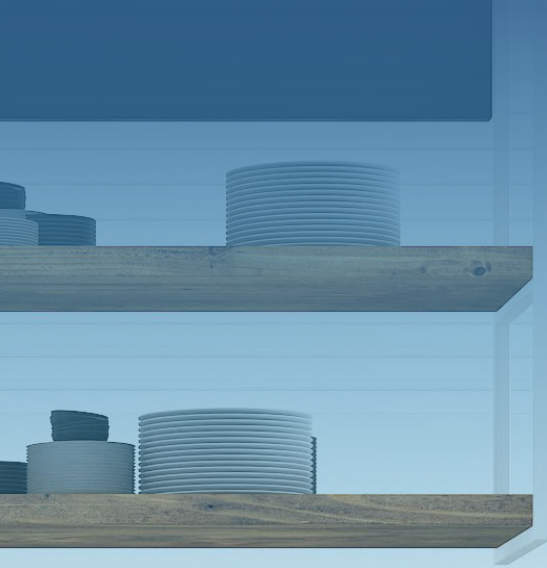



MPR2000-70 PLUS ① RAL6011 ② RAL6011 | RAL9010 ③ RAL9010



acabados y modelos · finishes and models

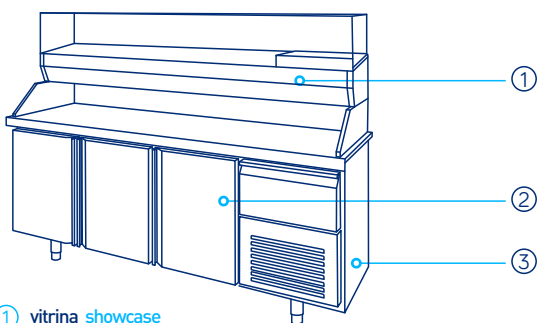

- ① vitrina showcase
- ② puertas, cajón y rejilla doors, drawer and grille
- ③ estructura principal principal structure



efecto cobre | latón  
| acero inoxidable |  
carta RAL (consultar)

effects copper | brass  
| stainless steel |  
RAL colour (check)

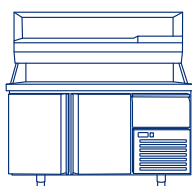

1498x600-700-800x1070mm



1990x600-700-800x1070mm

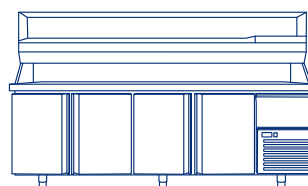

2482x600-700-800x1070mm

MPR1500-60	MPR1500-70	MPR1500-80	MPR2000-60	MPR2000-70	MPR2000-80	MPR2500-60	MPR2500-70	MPR2500-80
4.195 € (inox)	4.419 € (inox)	4.889 € (inox)	5.070 € (inox)	5.289 € (inox)	5.893 € (inox)	5.655 € (inox)	5.959 € (inox)	6.313 € (inox)

**índice index**

600-700 series

**MER Mesa fría ensalada**  
**MER Salad prep refrigerator table** 69



**MER Mesa fría ensalada (cajones)**  
**MER Salad refrigerator table (drawers)** 71



**MER Mesa fría ensalada (opciones)**  
**MER Salad refrigerator table (options)** 72



700 series

**MERT Mesa fría ensalada**  
**encimera abierta** 73  
**MERT Salad refrigerator table**  
**open worktop**



**MERT Mesa fría ensalada**  
**encimera abierta (opciones)** 74  
**MERT Salad refrigerator table**  
**open worktop (options)**



**MERV Mesa fría ensalada**  
**con vitrina cristal** 75  
**MERV Salad refrigerator table**  
**with glass display case**



**MERV Mesa fría ensalada**  
**con vitrina cristal (opciones)** 76  
**MERV Salad refrigerator table**  
**with glass display case (options)**



**Mesas frías ensalada PLUS line**  
**Salad refrigerators PLUS line** 77





modelo · model  
MER2000-60

encimera de granito opcional  
optional granite worktop

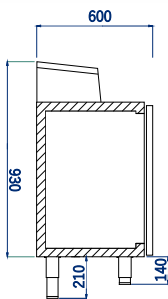

ficha técnica y modelos · technical sheet and models



							
	Consumo (W)	Potencia frigorífica (W)	Rango de temperatura (°C)	Estantes	Capacidad (L)	Capacidad (GN1/4)	Refrigerante
	Consumption (W)	Cooling capacity (W)	Temperature range	Shelves	Capacity (L)	Capacity (GN1/4)	Refrigerant
MER1500-60	272	508	0 / +8	2	240	9	R290
MER2000-60	570	802	0 / +8	3	372	12	R290
MER2500-60	777	992	0 / +8	4	581	15	R290



1498x600x1070 mm



1990x600x1070 mm



2482x600x1070 mm

\*el precio no incluye cubetas GN  
\*GN containers NOT included in price





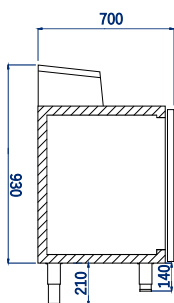

MER1500-60	MER2000-60	MER2500-60
3.175 €	3.719 €	4.263 €

modelo · model  
MER2500-70

encimera de granito opcional  
optional granite worktop



ficha técnica y modelos · technical sheet and models

	 Consumo (W) Consumption (W)	 Potencia frigorífica (W) Cooling capacity (W)	 Rango de temperatura (°C) Temperature range	 Estantes Shelves	 Capacidad (L) Capacity (L)	 Capacidad (GN1/4) Capacity (GN1/4)	 Refrigerante Refrigerant
MER1500-70	272	508	0 / +8	2	265	9	R290
MER2000-70	570	802	0 / +8	3	399	12	R290
MER2500-70	777	992	0 / +8	4	602	15	R290



1498x700x1070 mm



1990x700x1070 mm



2482x700x1070 mm

\*el precio no incluye cubetas GN  
\*GN containers NOT included in price







MER1500-70	MER2000-70	MER2500-70
3.321 €	3.944 €	4.466 €



modelo · model  
MER2000 cajones



ficha técnica y modelos · technical sheet and models

	 Consumo (W) Consumption (W)	 Potencia frigorífica (W) Cooling capacity (W)	 Rango de temperatura (°C) Temperature range	 Estantes Shelves	 Capacidad (L) Capacity (L)	 Capacidad (GN1/4) Capacity (GN1/4)	 Refrigerante Refrigerant
MER1500-60 cajones	272	508	0 / +8	2	240	9	R290
MER2000-60 cajones	570	802	0 / +8	3	372	12	R290
MER2500-60 cajones	777	992	0 / +8	4	581	15	R290
MER1500-70 cajones	272	508	0 / +8	2	240	9	R290
MER2000-70 cajones	570	802	0 / +8	3	372	12	R290
MER2500-70 cajones	777	992	0 / +8	4	581	15	R290

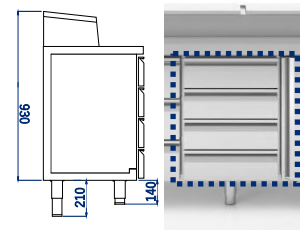
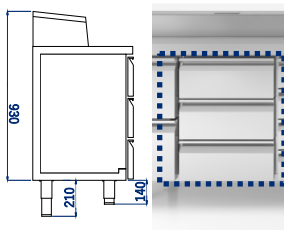
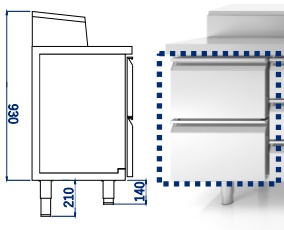

2 cajones kit 2 drawers kit	3 cajones kit 3 drawers kit	4 cajones kit 4 drawers kit
667 €	905 €	consultar



MER1500-60 · MPR1500-70	MER2000-60 · MER2000-70	MER2500-60 · MER2500-70
9x GN1/4-150	6x GN1/4-150 + 6x GN1/4-150	8x GN1/4-150 7x GN1/4-150

RESUMEN OPCIONES · options summary	PRECIO · price
Encimera granito · granite worktop	consultar
Respaldo acero inoxidable · stainless steel back	consultar
Juego 2 cajones · 2 drawers kit	667 €
Juego 3 cajones · 3 drawers kit	905 €
Juego 4 cajones · 4 drawers kit	consultar
Kit 4 ruedas · kit 4 wheels	148 €
Kit 6 ruedas · kit 6 wheels	223 €
Grupo izquierda · group opposite side	76 €
Cerradura (unidad) · lock (unit)	37 €
Parrilla adicional · extra wire shelf	42 €
Juego de guías · slides	40 €
Kit KVF [kit ventilación forzada] · forced ventilation kit	240 €





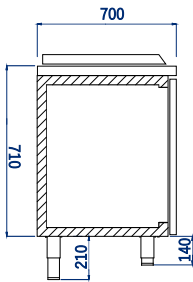

Imágenes y planos de producto no contractuales. Las características técnicas, dimensiones, acabados y opciones del producto sujetas a modificación por la empresa sin previo aviso.  
Non contractual plans and pictures. Apice reserves the right to change characteristics, measures, finishments and optional elements without prior notice.

modelo · model  
MERT1500



ficha técnica y modelos · technical sheet and models



	 Consumo (W) Consumption (W)	 Potencia frigorífica (W) Cooling capacity (W)	 Rango de temperatura (°C) Temperature range	 Estantes Shelves	 Capacidad (L) Capacity (L)	 Capacidad (GN1/4) Capacity (GN1/4)	 Refrigerante Refrigerant
MERT1500	272	508	0 / +8	2	251	15	R290
MERT2000	272	508	0 / +8	3	394	24	R290



1498x700x850 mm



1990x700x850 mm

\*el precio no incluye cubetas GN  
\*GN containers NOT included in price

MERT1500	MERT2000
3.170 €	3.789 €



MERT1500	MERT2000
15x GN1/6	12x GN1/6 + 12x GN1/6

RESUMEN OPCIONES · options summary	PRECIO · price
Respaldo acero inoxidable · stainless steel back	consultar
Kit 4 ruedas · kit 4 wheels	148 €
Kit 6 ruedas · kit 6 wheels	223 €
Grupo izquierda · group opposite side	76 €
Cerradura (unidad) · lock (unit)	37 €
Parrilla adicional · extra wire shelf	42 €
Juego de guías · slides	40 €
Kit KVF (kit ventilación forzada) · forced ventilation kit	240 €



# Mesa fría ensalada vitrina cristal

Salad prep refrigerator table glass display case

# 700 SERIES

modelo · model  
**MERV2000**



ficha técnica y modelos · technical sheet and models

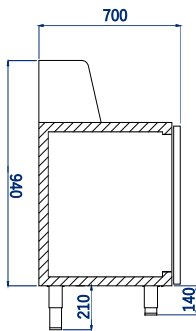

	Consumo (W) Consumption (W)	Potencia frigorífica (W) Cooling capacity (W)	Rango de temperatura (°C) Temperature range	Estantes Shelves	Capacidad (L) Capacity (L)	Capacidad (GN1/4) Capacity (GN1/4)	Refrigerante Refrigerant
MERV1500	272	508	0 / +8	2	251	15	R290
MERV2000	570	802	0 / +8	3	394	24	R290



1498x700x1080 mm



1990x700x1080 mm

\*el precio no incluye cubetas GN  
\*GN containers NOT included in price

MERV1500	MERV2000
3.623 €	4.242 €

# Mesa fría ensalada vitrina cristal opciones

Salad prep refrigerator table glass display case

# 700 SERIES



MERV1500	MERV2000
6x GN1/6	9x GN1/6

RESUMEN OPCIONES · options summary	PRECIO · price
Respaldo acero inoxidable · stainless steel back	consultar
Kit 4 ruedas · kit 4 wheels	148 €
Kit 6 ruedas · kit 6 wheels	223 €
Grupo izquierda · group opposite side	76 €
Cerradura (unidad) · lock (unit)	37 €
Parrilla adicional · extra wire shelf	42 €
Juego de guías · slides	40 €
Kit KVF (kit ventilación forzada) · forced ventilation kit	240 €

¿quieres personalizar los acabados de tu producto?  
bienvenido a nuestra sección HORECA Plus

600-700 SERIES  
PLUS

## Mesa fría ensalada PLUS line

Salad prep refrigerator table PLUS line





# MER | MERT | MERV

Mesa fría ensalada | abierta | vitrina cristal

Salad prep refrigerator table | open worktop | glass display case

600-700 SERIES PLUS

**MER1500-60 PLUS** ① cobre | cupper ② cobre | cupper ③ cobre | cupper ④ cobre | cupper



acabados y modelos · finishes and models

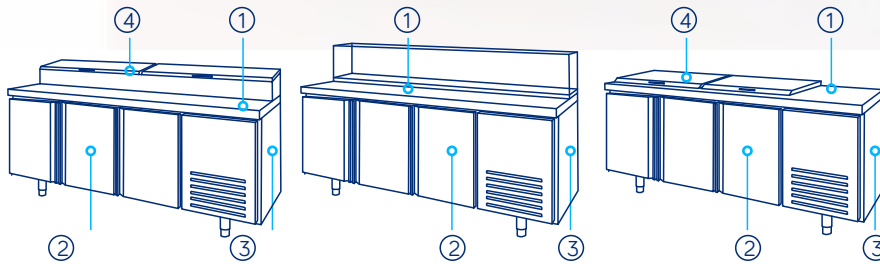

① encimera + peto countertop + bib

② puertas y/o cajones y rejilla doors, drawers and grille

③ estructura principal principal structure

④ puertas abatibles folding doors



efecto cobre | latón | acero inoxidable | carta RAL (consultar)

effects copper | brass | stainless steel | RAL colour (check)

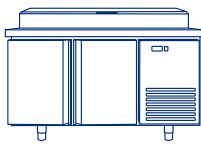

1498x600-700x1070mm

MER1500-60+

3.493 € (base inox)



MER1500-70+

3.653 € (base inox)

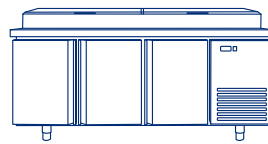

1990x600-700x1070mm

MER2000-60+

4.091 € (base inox)



MER2000-70+

4.338 € (base inox)

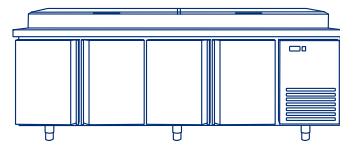

2482x600-700x1070mm

MER2500-60+

4.689 € (base inox)

MER2500-70+

4.913 € (base inox)

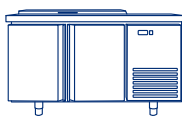

1498x700x850 mm

MERT1500+

3.487 € (base inox)

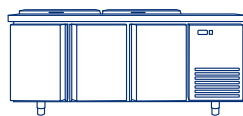

1990x700x850 mm

MERT2000+

4.168 € (base inox)

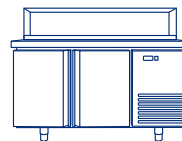

1498x700x1080 mm

MERV1500+

3985 € (base inox)

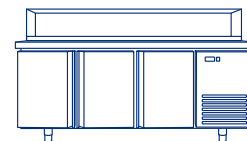

1990x700x1080 mm

MERV2000+

4.666 € (base inox)





# Armarios Cabinets

# Armarios Cabinets

## Índice index

### Snack series

ARS refrigerado	ARS refrigerator	82
ARS refrigerado puertas divididas	ARS refrigerator divided doors	83
ARS refrigerado puertas cristal	ARS refrigerator with glass doors	84
ACS congelación	ACS freezer	85
ARCS refrigeración y congelación	ARCS refrigerator and freezer	86
ARS/ACS opciones	ARS/ACS options	87
<b>Armario snack series PLUS line</b>		<b>88</b>

### Armarios Gastronorm

#### GN1/1 series

ARG refrigerado	ARG refrigerator	92
ARG refrigerado puertas divididas	ARG refrigerator divided doors	93
ARG refrigerado puertas cristal	ARG refrigerator with glass doors	94
ACG congelación	ACG freezer	95
ARCG refrigeración y congelación	ARCG refrigerator and freezer	96
ARG/ARC opciones	ARG/ARC options	97

#### GN2/1 series

ARG refrigerado	ARG refrigerator	99
ARG refrigerado puertas divididas	ARG refrigerator divided doors	100
ARG refrigerado puertas cristal	ARG refrigerator with glass doors	101
ACG congelación	ACG freezer	102
ARCG refrigeración y congelación	ARCG refrigerator and freezer	103
ARG/ARC opciones	ARG/ARC options	104
<b>Armarios GN series PLUS line</b>		<b>105</b>

**índice index**

**ARS**  
**ARS (refrigerator)** **82**

---



**ARS (puertas divididas)**  
**ARS (divided doors)** **83**

---



**ARS (puertas cristal)**  
**ARS (glass doors)** **84**

---



**ACS (congelación)**  
**ACS (freezer)** **85**

---



**ARCS (refrigeración y congelación)**  
**ARCS (refrigerator and freezer)** **86**

---



**ARS/ARC (opciones)**  
**ARS/ARC (options)** **87**

---



**Armario snack PLUS line**  
**Snack size cabinet PLUS line** **88**

---









modelo · model  
**ARS700**



modelo · model  
**ARS1400**



ficha técnica y modelos · technical sheet and models

	 Consumo (W) Consumption (W)	 Potencia frigorífica (W) Cooling capacity (W)	 Rango de temperatura (°C) Temperature range	 Estantes Shelves	 Capacidad (L) Capacity (L)	 Refrigerante Refrigerant	 CEE ECC
ARS700	252	265	-2 / +8	3	522	R290	C
ARS1400	531	833	-2 / +8	6	1260	R290	D

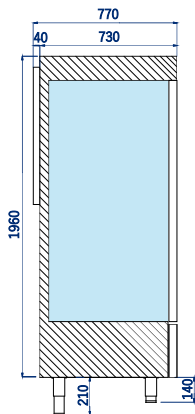

698x770x2102 mm	1398x770x2102 mm
ARS700	ARS1400
2.465 €	3.356 €









modelo · model  
**ARS700 (2 puertas)**



modelo · model  
**ARS1400 (3 puertas)**



ficha técnica y modelos · technical sheet and models

	 Consumo (W) Consumption (W)	 Potencia frigorífica (W) Cooling capacity (W)	 Rango de temperatura (°C) Temperature range	 Estantes Shelves	 Capacidad (L) Capacity (L)	 Refrigerante Refrigerant	 CEE ECC
ARS700 (2 puertas)	252	265	-2 / +8	3	522	R290	C
ARS1400 (3 puertas)	531	833	-2 / +8	6	1260	R290	D
ARS1400 (4 puertas)	531	833	-2 / +8	6	1260	R290	D

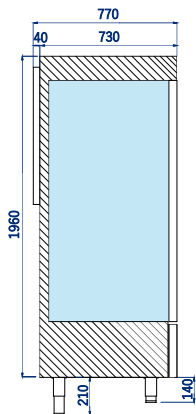

		
698x770x2102 mm	1398x770x2102 mm	1398x770x2102 mm
ARS700 (2puertas)	ARS1400 (3puertas)	ARS1400 (4 puertas)
2.523 €	3.429 €	3.466 €

# Armario snack refrigeración puertas cristal

Snack size refrigerator cabinet with glass doors

# SNACK SERIES







modelo · model  
**ARS700C**





modelo · model  
**ARS1400C**

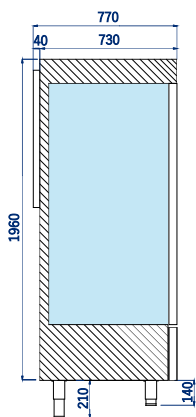

ficha técnica y modelos · technical sheet and models

	 Consumo (W) Consumption (W)	 Potencia frigorífica (W) Cooling capacity (W)	 Rango de temperatura (°C) Temperature range	 Estantes Shelves	 Capacidad (L) Capacity (L)	 Refrigerante Refrigerant	 CEE ECC
ARS700C	272	502	-2 / +8	4	520	R290	C
ARS1400C	562	845	-2 / +8	8	1260	R290	D



	
698x770x2102 mm	1398x770x2102 mm
ARS700C	ARS1400C
2.575 €	3.848 €







modelo · model  
**ACS700**



modelo · model  
**ACS1400C**



ficha técnica y modelos · technical sheet and models

	 Consumo (W) Consumption (W)	 Potencia frigorífica (W) Cooling capacity (W)	 Rango de temperatura (°C) Temperature range	 Estantes Shelves	 Capacidad (L) Capacity (L)	 Refrigerante Refrigerant	 CEE ECC
ACS700	566	626	-20 / -15	3	498	R290	E
ACS700C	588	666	-20 / -15	4	498	R290	E
ACS1400	898	934	-20 / -15	6	1228	R290	F
ACS1400C	922	962	-20 / -15	8	1228	R290	F

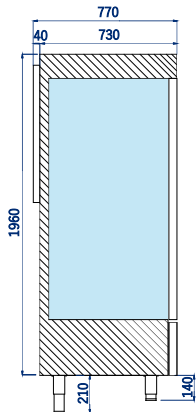

698x770x2102 mm		1398x770x2102 mm	
ACS700	ACS700C	ACS1400	ACS1400C
3.456 €	4.142 €	4.501 €	6.031 €







modelo · model  
**ARCS700**



modelo · model  
**ARCS1400**



ficha técnica y modelos · technical sheet and models

	 Consumo (W) Consumption (W)	 Potencia frigorífica (W) Cooling capacity (W)	 Rango de temperatura (°C) Temperature range	 Estantes Shelves	 Capacidad (L) Capacity (L)	 Refrigerante Refrigerant	 CEE ECC
ARCS700	366+366	210+210	-2 / +8 -20 / -15	3	522	R290	
ARCS1400	511+511	323+323	-2 / +8 -20 / -15	6	1260	R290	

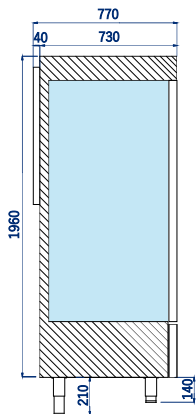

698x770x2102 mm	1398x770x2102 mm
ARCS700	ARCS1400
4.260 €	5.443 €



## Armario snack opciones

Snack size refrigerator and freezer cabinet options

# SNACK SERIES



listado de opciones y precio · options list and price

RESUMEN OPCIONES · options summary	PRECIO · price
Respaldo acero inoxidable · stainless steel back	consultar
Kit 4 ruedas · kit 4 wheels	148 €
Grupo tropicalizado (43°C) · tropicalized group	consultar
Cerradura (unidad) · lock (unit)	37 €
Cerradura puerta cristal (unidad) lock glass door (unit)	62 €
Parrilla adicional · extra wire shelf	42 €
Juego de guías · slides	40 €

¿quieres personalizar los acabados de tu producto?  
bienvenido a nuestra sección HORECA Plus

SNACK SERIES  
PLUS

## Armario snack refrigeración y congelación

Snack size refrigeration and freezer cabinet



## ARS700 PLUS ① RAL1032 ② RAL9010



### acabados y modelos · finishes and models

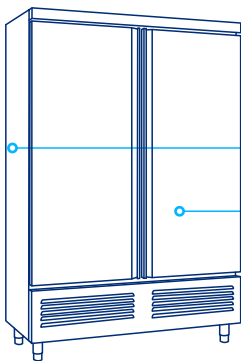

- ① estructura principal  
principal structure
- ② puertas y rejilla  
doors and grille



efecto cobre | latón  
| acero inoxidable |  
carta RAL (consultar)

effects copper | brass  
| stainless steel |  
RAL colour (check)

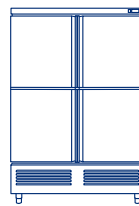
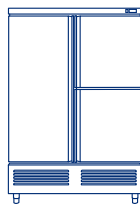
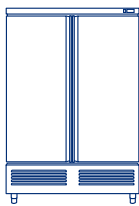
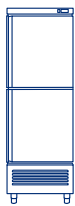

698x770x2102 mm		1398x770x2102 mm		
ARS700+	ARS700 2P+	ARS1400+	ARS1400 3P+	ARS1400 4P+
2.712 € (inox)	2.775 € (inox)	3.692 € (inox)	3.772 € (inox)	3.813 € (inox)

698x770x2102mm	1398x770x2102mm
ACS700+	ACS1400+
3.802 € (inox)	4.951 € (inox)



### ARS1400C PLUS ① RAL5020 ② Latón | Brass



#### acabados y modelos · finishes and models

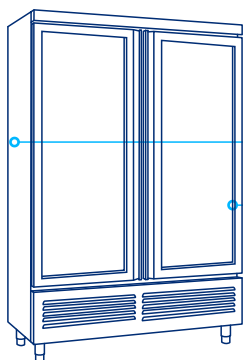

① estructura principal  
principal structure

② puertas y rejilla  
doors and grille



efecto cobre | latón  
| acero inoxidable |  
carta RAL (consultar)

effects copper | brass  
| stainless steel |  
RAL colour (check)

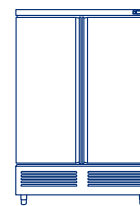

698x770x2102 mm		1398x770x2102 mm	
ARS700C+	ACS700C+	ARS1400C+	ACS1400C+
2.833 € (inox)	4.556 € (inox)	4.233 € (inox)	6634 € (inox)

698x770x2102mm	1398x770x2102mm
ARCS700+	ARCS1400+
4.686 € (inox)	5.987 € (inox)



**índice index**

**ARG**  
**ARG (refrigerator)** 92

---



**ARG (puertas divididas)**  
**ARG (divided doors)** 93

---



**ARG (puertas cristal)**  
**ARG (glass doors)** 94

---



**ACG (congelación)**  
**ACG (freezer)** 95

---



**ARCG (refrigeración y congelación)**  
**ARCG (refrigerator and freezer)** 96

---



**ARG/ARC (opciones)**  
**ARG/ARC (options)** 97

---



**Armario Gastronorm PLUS line**  
**Gastronorm size cabinet PLUS line** 105

---











modelo · model  
**ARG500**



modelo · model  
**ARG1000**



ficha técnica y modelos · technical sheet and models

								
	Consumo (W)	Potencia frigorífica (W)	Rango de temperatura (°C)	Estantes	Pares guías	Capacidad (L)	Refrigerante	CEE
	Consumption (W)	Cooling capacity (W)	Temperature range	Shelves	Slides sets	Capacity (L)	Refrigerant	ECC
ARG500	177	383	-2 / +8	3	3	440	R290	C
ARG1000	411	525	-2 / +8	6	6	920	R290	D

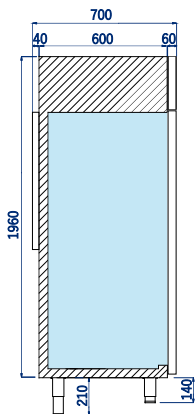

496x700x2102 mm	1002x700x2102 mm
ARG500	ARG1000
2.215 €	2.994 €

modelo · model  
**ARG500 (2 puertas)**

modelo · model  
**ARG1000 (4 puertas)**



ficha técnica y modelos · technical sheet and models

	 Consumo (W) Consumption (W)	 Potencia frigorífica (W) Cooling capacity (W)	 Rango de temperatura (°C) Temperature range	 Estantes Shelves	 Pares guías Slides sets	 Capacidad (L) Capacity (L)	 Refrigerante Refrigerant	 CEE ECC
ARG500 (2 puertas)	177	383	-2 / +8	3	3	440	R290	C
ARG1000 (3 puertas)	411	525	-2 / +8	6	6	920	R290	D
ARG1000 (4 puertas)	411	525	-2 / +8	6	6	920	R290	D

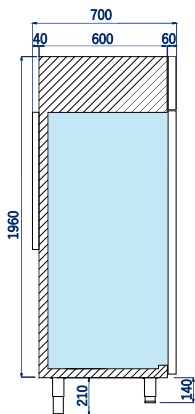

		
496x700x2102 mm	1002x700x2102 mm	1002x700x2102 mm
ARG500 (2puertas)	ARG1000 (3puertas)	ARG1000 (4 puertas)
2.320 €	3.041 €	3.097 €

# Armario Gastronorm refrigeración puertas cristal

Gastronorm size refrigerator cabinet with glass doors

# GN1/1 SERIES







modelo · model  
**ARG500C**



modelo · model  
**ARG1000C**



ficha técnica y modelos · technical sheet and models

	 Consumo (W) Consumption (W)	 Potencia frigorífica (W) Cooling capacity (W)	 Rango de temperatura (°C) Temperature range	 Estantes Shelves	 Capacidad (L) Capacity (L)	 Refrigerante Refrigerant	 CEE ECC
ARG500C	232	442	-2 / +8	4	440	R290	C
ARG1000C	448	780	-2 / +8	8	780	R290	C

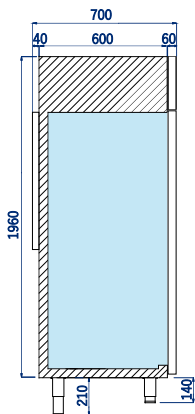

496x700x2102 mm	1002x700x2102 mm
ARG500C	ARG1000C
2.523 €	3.651 €









modelo · model  
**ACG500C**



modelo · model  
**ACG1000**



ficha técnica y modelos · technical sheet and models

	 Consumo (W) Consumption (W)	 Potencia frigorífica (W) Cooling capacity (W)	 Rango de temperatura (°C) Temperature range	 Estantes Shelves	 Capacidad (L) Capacity (L)	 Refrigerante Refrigerant	 CEE ECC
ACG500	456	511	-20 / -15	3	440	R290	C
ACG500C	471	524	-20 / -15	4	440	R290	C
ACG1000	778	831	-20 / -15	6	920	R290	D
ACG1000C	811	862	-20 / -15	8	920	R290	D

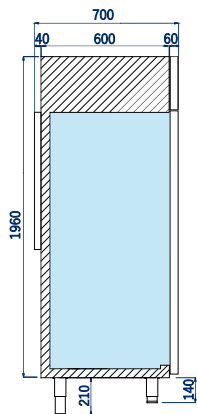







496x700x2102 mm		1002x700x2102 mm	
ACG500	ACG500C	ACG1000	ACG1000C
2.888 €	3.107 €	3.943 €	4.498 €

modelo · model  
**ARCG500**

modelo · model  
**ARCG1000**



ficha técnica y modelos · technical sheet and models

	 Consumo (W) Consumption (W)	 Potencia frigorífica (W) Cooling capacity (W)	 Rango de temperatura (°C) Temperature range	 Estantes Shelves	 Capacidad (L) Capacity (L)	 Refrigerante Refrigerant	 CEE ECC
ARCG500	191+277	216+302	-2 / +8 -20 / -15	3	440	R290	
ARCG1000	218+511	225+551	-2 / +8 -20 / -15	6	920	R290	

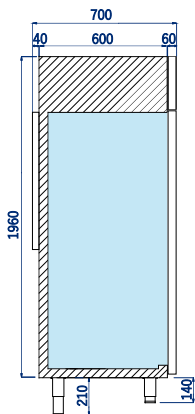

496x700x2102 mm	1002x700x2102 mm
ARCG500	ARCG1000
3.707 €	4.762 €



[listado de opciones y precio · options list and price](#)

RESUMEN OPCIONES · options summary	PRECIO · price
Respaldo acero inoxidable · stainless steel back	consultar
Kit 4 ruedas · kit 4 wheels	148 €
Grupo tropicalizado (43°C) · tropicalized group	consultar
Cerradura (unidad) · lock (unit)	37 €
Cerradura puerta cristal (unidad) lock glass door (unit)	62 €
Parrilla adicional · extra wire shelf	42 €
Juego de guías · slides	40 €

**índice index**

**ARG**  
**ARG (refrigerator)** **99**

---



**ARG (puertas divididas)**  
**ARG (divided doors)** **100**

---



**ARG (puertas cristal)**  
**ARG (glass doors)** **101**

---



**ACG (congelación)**  
**ACG (freezer)** **102**

---



**ARCG (refrigeración y congelación)**  
**ARCG (refrigerator and freezer)** **103**

---



**ARG/ARC (opciones)**  
**ARG/ARC (options)** **104**

---



**Armario Gastronorm PLUS line**  
**Gastronorm size cabinet PLUS line** **105**

---









modelo · model  
**ARG700**



modelo · model  
**ARG1400**



ficha técnica y modelos · technical sheet and models

	 Consumo (W) Consumption (W)	 Potencia frigorífica (W) Cooling capacity (W)	 Rango de temperatura (°C) Temperature range	 Estantes Shelves	 Capacidad (L) Capacity (L)	 Refrigerante Refrigerant	 CEE ECC
<b>ARG700</b>	194	516	-2 / +8	3	622	R290	C
<b>ARG1400</b>	440	762	-2 / +8	6	1356	R290	C

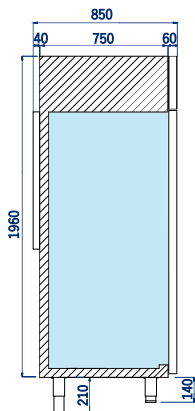

698x850x2008 mm	1398x850x2008 mm
<b>ARG700</b>	<b>ARG1400</b>
2.750 €	4.249 €





modelo · model  
**ARG700 (2 puertas)**



modelo · model  
**ARG1400 (3 puertas)**



ficha técnica y modelos · technical sheet and models

	 Consumo (W) Consumption (W)	 Potencia frigorífica (W) Cooling capacity (W)	 Rango de temperatura (°C) Temperature range	 Estantes Shelves	 Capacidad (L) Capacity (L)	 Refrigerante Refrigerant	 CEE ECC
ARG700 (2 puertas)	194	516	-2 / +8	3	622	R290	C
ARG1400 (3 puertas)	440	762	-2 / +8	6	1356	R290	C
ARG1400 (4 puertas)	440	762	-2 / +8	6	1356	R290	C

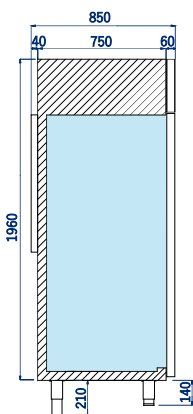

698x850x2008 mm	1398x850x2008 mm	1398x850x2008 mm
ARG700 (2puertas)	ARG1400 (3puertas)	ARG1400 (4 puertas)
2.841 €	4.277 €	4.331 €







modelo · model  
**ARG700C**



modelo · model  
**ARG1400C**



ficha técnica y modelos · technical sheet and models

	 Consumo (W) Consumption (W)	 Potencia frigorífica (W) Cooling capacity (W)	 Rango de temperatura (°C) Temperature range	 Estantes Shelves	 Capacidad (L) Capacity (L)	 Refrigerante Refrigerant	 CEE ECC
ARG700C	278	516	-2 / +8	4	622	R290	C
ARG1400C	566	860	-2 / +8	8	1356	R290	C

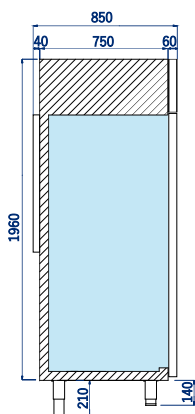

698x850x2008 mm	1398x850x2008 mm
ARG700C	ARG1400C
3.129 €	4.750 €







modelo · model  
**ACG700**



modelo · model  
**ACG1400C**



ficha técnica y modelos · technical sheet and models

	 Consumo (W) Consumption (W)	 Potencia frigorífica (W) Cooling capacity (W)	 Rango de temperatura (°C) Temperature range	 Estantes Shelves	 Capacidad (L) Capacity (L)	 Refrigerante Refrigerant	 CEE ECC
ACG700	580	618	-20 / -15	3	622	R290	C
ACG700C	611	644	-20 / -15	4	622	R290	D
ACG1400	890	881	-20 / -15	6	1356	R290	C
ACG1400C	898	875	-20 / -15	8	1356	R290	D

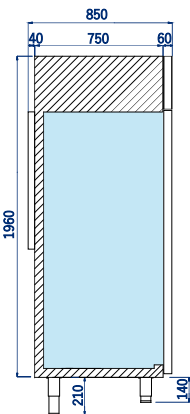

698x850X2008 mm		1398x850x2008 mm	
ACG700	ACG700C	ACG1400	ACG1400C
3.682 €	4.352 €	5.166 €	6.434 €







modelo · model  
**ARCG700**



modelo · model  
**ARCG1400**



ficha técnica y modelos · technical sheet and models

	 Consumo (W) Consumption (W)	 Potencia frigorífica (W) Cooling capacity (W)	 Rango de temperatura (°C) Temperature range	 Estantes Shelves	 Capacidad (L) Capacity (L)	 Refrigerante Refrigerant	 CEE ECC
<b>ARCG700</b>	211+304	266+338	-2 / +8 -20 / -15	3	622	R290	
<b>ARCG1400</b>	261+566	257+614	-2 / +8 -20 / -15	6	1356	R290	

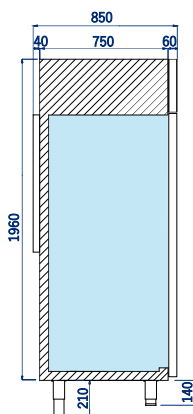

	
698x850x2008 mm	1398x850x2008 mm
<b>ARCG700</b>	<b>ARCG1400</b>
4.350 €	6.317 €



listado de opciones y precio · options list and price

RESUMEN OPCIONES · options summary	PRECIO · price
Respaldo acero inoxidable · stainless steel back	consultar
Kit 4 ruedas · kit 4 wheels	148 €
Grupo tropicalizado (43°C) · tropicalized group	consultar
Cerradura (unidad) · lock (unit)	37 €
Cerradura puerta cristal (unidad) lock glass door (unit)	62 €
Parrilla adicional · extra wire shelf	42 €
Juego de guías · slides	40 €



¿quieres personalizar los acabados de tu producto?  
bienvenido a nuestra sección HORECA Plus

GN1/1-GN2/1 SERIES  
PLUS

## Armario Gastronorm refrigeración y congelación

Gastrorm size refrigeration and freezer cabinet



### ARG1400 3P PLUS ① RAL7044 ② RAL7044



#### acabados y modelos · finishes and models

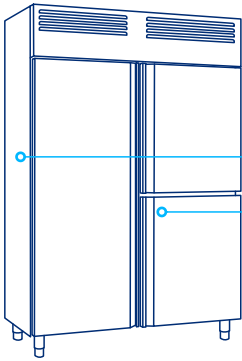

- ① estructura principal  
principal structure
- ② puertas y rejillas  
doors and grilles



efecto cobre | latón  
| acero inoxidable |  
carta RAL (consultar)

effects copper | brass  
| stainless steel |  
RAL colour (check)

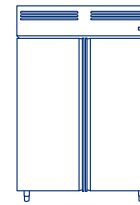
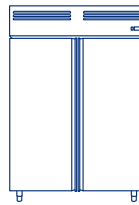
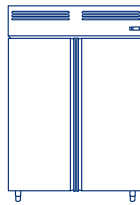
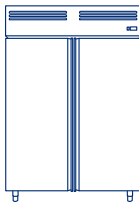

496x700x2102 mm		1002x700x2102 mm		
ARG500+	ARG500 2P+	ARG1000+	ARG1000 3P+	ARG1000 4P+
2.437 € (inox)	2.552 € (inox)	2.523 € (inox)	3.345 € (inox)	3.407 € (inox)
698x850x2008 mm		1398x850x2008 mm		
ARG700+	ARG700 2P+	ARG1400+	ARG1400 3P+	ARG1400 4P+
3.025 € (inox)	3.125 € (inox)	4.674 € (inox)	4.705 € (inox)	4.764 € (inox)

GN1/1

GN2/1

496x700x2102 mm	1002x700x2102 mm
ACG500+	ACG1000+
3.177 € (inox)	4.337 € (inox)
698x850x2008 mm	1398x850x2008 mm
ACG700+	ACG1400
4.050 € (inox)	5.683 € (inox)



### ARG500C PLUS

① RAL8017 ② RAL8017



#### acabados y modelos · finishes and models

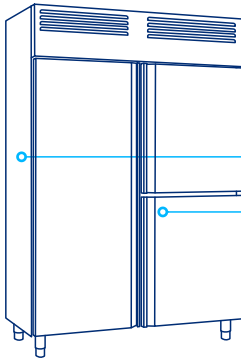

- ① estructura principal  
principal structure
- ② puertas y rejillas  
doors and grilles



efecto cobre | latón  
| acero inoxidable |  
carta RAL (consultar)

effects copper | brass  
| stainless steel |  
RAL colour (check)

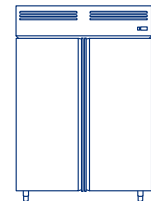
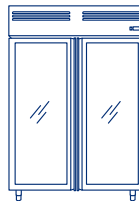

496x700x2102 mm		1002x700x2102 mm	
ARG500C+	ACG500C+	ARG1000C+	ACG1000C+
2.775 € (inox)	3.418 € (inox)	4.016 € (inox)	4.948 € (inox)
698x850x2008 mm		1398x850x2008 mm	
ARG700C+	ACG700C+	ARG1400C+	ACG1400C+
3.442 € (inox)	4.787 € (inox)	5.225 € (inox)	7.077 € (inox)

GN1/1

GN2/1

496x700x2102 mm	1002x700x2102 mm
ARG500+	ARG1000+
4.078 € (inox)	5.238 € (inox)
698x850x2008 mm	1398x850x2008 mm
ARG700+	ARG1400
4.785 € (inox)	6.949 € (inox)



# Cocktelería Cocktail bar

**índice index**

**MNK cocktelería neutra**  
**MNK cocktail bar without refrigeration** **110**

---



**MRK cocktelería con refrigeración**  
**MRK cocktail bar refrigerator** **111**

---



**MNK-MRK opciones**  
**MNK-MRK options** **112**

---



**Cocktelería PLUS line**  
**PLUS line cocktail bar** **113**

---











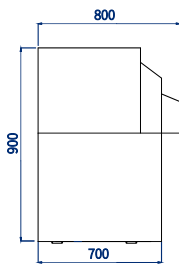

modelo · model  
**MNK1400**



ficha técnica y modelos · technical sheet and models



	 Consumo (W) Consumption (W)	 Potencia frigorífica (W) Cooling capacity (W)	 Rango de temperatura (°C) Temperature range	 Estantes Shelves	 Capacidad (L) Capacity (L)	 Refrigerante Refrigerant	 CEE ECC
MNK1400	-	-	-	1	-	-	-
MNK1800	-	-	-	1	-	-	-

\*cubetas GN no incluidas  
\*GN containers NOT included



1400x800x900 mm	1800x800x900 mm
MNK1400	MNK1800
2.138 €	2.783 €







modelo · model  
**MRK1800**

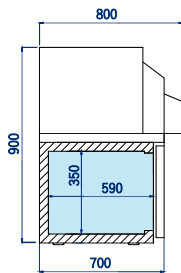

espacio batidora  
shelf for blender

ficha técnica y modelos · technical sheet and models



							
	Consumo (W)	Potencia frigorífica (W)	Rango de temperatura (°C)	Estantes	Capacidad (L)	Refrigerante	CEE
	Consumption (W)	Cooling capacity (W)	Temperature range	Shelves	Capacity (L)	Refrigerant	ECC
<b>MRK1400 (2cajones)</b>	240	290	-2/ +8	-	196	R290	B
<b>MRK1800 (3 cajones)</b>	370	302	-2 / +8	-	260	R290	B

\*cubetas GN no incluidas \*GN containers NOT included  
\*sin desagüe inferior \*without internal drain



1400x800x900 mm	1800x800x900 mm
MRK1400	MRK1800
5.837 €	6.550 €

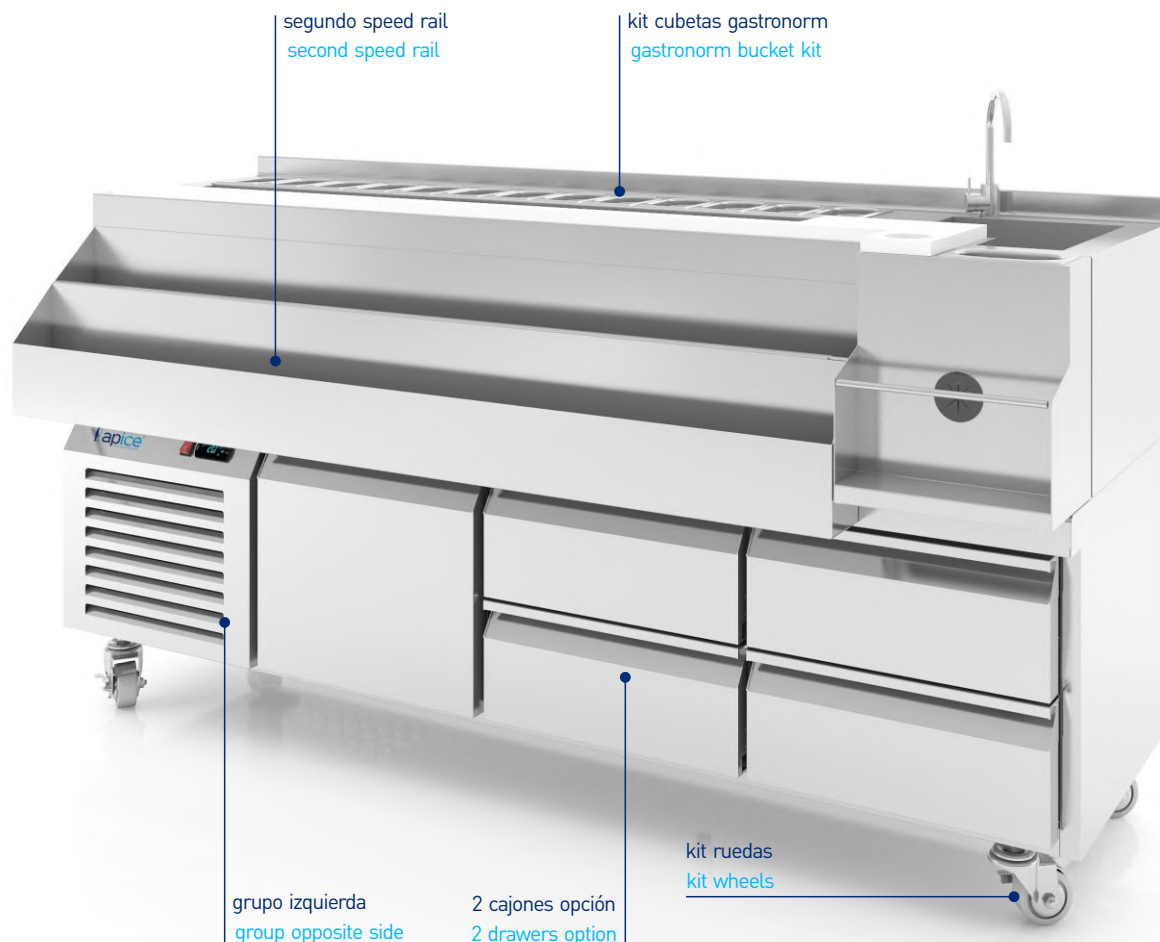

listado de opciones y precio · options list and price

RESUMEN OPCIONES · options summary	PRECIO · price
Respaldo acero inoxidable cuerpo inferior · stainless steel back lower element	consultar
Juego 2 cajones · 2 drawers kit	412 €
Kit 4 ruedas · kit 4 wheels	148 €
Grupo izquierda · group opposite side	76 €
Grupo tropicalizado (43°C) · tropicalized group	consultar
9 cubetas GN 1/9 100mm (modelos 1400) · gastronorm bucket GN1/9 100mm kit (1400 series)	185 €
13 cubetas GN 1/9 100mm (modelos 1800) · gastronorm bucket GN1/9 100mm kit (1800 series)	288 €
segundo speed rail (modelos 1400) · second speed rail (1400 series)	167 €
segundo speed rail (modelos 1800) · second speed rail (1800 series)	181 €



¿quieres personalizar los acabados de tu producto? bienvenido a nuestra sección HORECA Plus

700 SERIES  
PLUS

## Cocktelería PLUS line

Cocktail bar PLUS line



### MRK1400 PLUS

① RAL7024 ② RAL7024



#### acabados y modelos · finishes and models

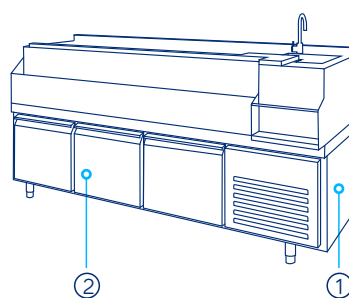
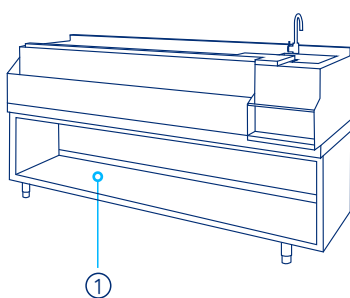

① estructura principal principal structure  
cuerpo inferior of lower element

② cajones y rejilla drawers and grille

efecto cobre | latón  
| acero inoxidable |  
carta RAL (consultar)

effects copper | brass  
| stainless steel |  
RAL colour (check)

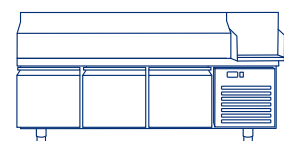
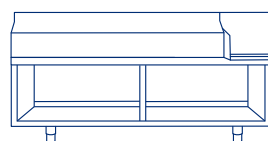
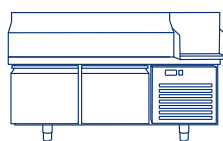
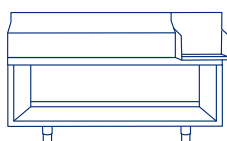

1400x800x900 mm	1400x800x900 mm	1800x800x900 mm	1800x800x900 mm
MNK1400	MRK1400	MNK1800	MRK1800
2.352 € (base inox)	6.421 € (base inox)	3.062 € (base inox)	7.205 € (base inox)





## Pedidos

Los pedidos deberán cursarse por escrito (carta, fax o e-mail). Deberán reflejar las referencias de cada producto, indicadas en la tarifa vigente. Queda reservado a admitir pedidos de aquellos clientes que hayan incumplido anteriores contratos. Las condiciones particulares que se citen en el pedido del cliente quedarán anuladas si no se ajustan a las presentes condiciones generales de venta o que se acepten expresamente.



## Precios

Los precios de la presente lista son de venta al público (recomendados) y figuran en Euros. Estos precios, en ningún caso, incluyen la instalación ni la puesta en marcha del material. Todos los precios se entienden sin accesorios.



## Transporte y portes

El embalaje será el estándar. Cualquier embalaje o sistema de envío especial que sea requerido expresamente por el cliente, será a cargo de este último. Las mercancías viajan siempre por cuenta y riesgo del comprador. Recomendamos encarecidamente realice el control del estado de la mercancía en el tiempo establecido ya que, de lo contrario, Apice cooling technology S.L. declina toda responsabilidad al comprador. La reclamación por golpes o deterioro de la mercancía originados en el transporte no será aceptada, en ningún caso, si no va acompañada del comprobante de reclamación efectuada por el comprador a la agencia de transporte, dentro del plazo máximo legal de 24 horas después de la recepción de la mercancía.



## Devoluciones de material

No se aceptará ninguna devolución del material sin el consentimiento expreso y por escrito de Apice cooling technology S.L. En el caso de la aceptación de una devolución de material, todos los gastos generados, incluidos los portes correrán a cargo del cliente. Los materiales se abonarán de acuerdo con las condiciones del estado de la mercancía, reservándose Apice cooling technology S.L. el derecho a estipular el precio final del abono.



## Garantía

Apice cooling technology S.L. se responsabilizará únicamente de los defectos de fabricación, quedando excluidos la manipulación o utilización incorrecta del material por parte del cliente o usuario. La garantía será la establecida según la ley vigente (1 año). Todo material remitido en garantía se facturará y se procederá a su correspondiente abono, una vez remitidas las piezas defectuosas y comprobadas por parte de Apice cooling technology S.L.



## Condiciones de pago

Hasta la concesión de crédito a un cliente, todas las operaciones serán abonadas mediante pago anticipado. De no efectuarse el pago de las facturas en los vencimientos acordados, el cliente se hará cargo de los gastos de devolución y/o gastos de demora.



## Envío de repuestos

Todos los repuestos se enviarán a portes debidos.



## Reserva de dominio

La mercancía es propiedad y dominio de Apice cooling technology S.L. hasta el pago total de la misma por parte del cliente.



## Litigio

En este caso serán competentes los Tribunales de Lucena (Córdoba)



## Información

Apice cooling technology S.L. se reserva el derecho a introducir, sin previo aviso, las modificaciones que crea necesarias, sin que ello perjudique a las características principales de los productos.



## Orders

Orders must be submitted in writing (letter, fax or e-mail). They should reflect the references of each product, indicated in the current rate. It is reserved to accept orders from those customers who have breached previous contracts. The particular conditions that are cited in the customer's order will be canceled if they are not adjusted to these general conditions of sale or that are expressly accepted.



## Prices

The prices in this list are for sale to the public (recommended) and are in Euros. These prices, in no case, include the installation or commissioning of the material. All prices are understood without accessories.



## Transportation and shipping

Packaging will be the standard. Any packaging or special delivery system that is expressly required by the customer will be the responsibility of the latter. Goods always travel at the buyer's risk and expense. We strongly recommend that you check the status of the merchandise within the established time since, otherwise, Apice cooling technology S.L. declines all responsibility to the buyer. The claim for blows or deterioration of the merchandise originating in the transport will not be accepted, in any case, if it is not accompanied by the receipt of claim made by the buyer to the transport agency, within the maximum legal term 24 hours after receipt of the products.



## Material returns

No return of the material will be accepted without the express written consent of Apice cooling technology S.L. In the case of the acceptance of a return of material, all the expenses generated, including the postage will be borne by the customer. The materials will be paid in accordance with the conditions of the state of the merchandise, reserving Apice cooling technology S.L. the right to stipulate the final price of the subscription.



## Guarantee

Apice cooling technology S.L. will be responsible only for manufacturing defects, excluding the improper handling or use of the material by the customer or user. The guarantee will be established according to current law (1 year). All material sent under warranty will be invoiced and the corresponding payment will be made, once the defective parts have been sent and checked by Apice cooling technology S.L.



## Payment conditions

Until the granting of credit to a client, all operations will be paid by prepayment. If the payment of the invoices is not made on the agreed deadlines, the customer will be responsible for the return costs and / or delay costs.



## Shipping of spare parts

All spare parts will be shipped freight collect.



## Domain reservation

The merchandise is property and domain of Apice cooling technology S.L. until the total payment of the same by the client.



## Litigation

In this case, the Courts of Lucena (Córdoba) will be competent.



## Information

Apice cooling technology S.L. reserves the right to introduce, without prior notice, the modifications it deems necessary, without prejudice to the main characteristics of the products.









# HO RE CA line &plus 2024



C/Badajoz, 12  
Parque empresarial Príncipe Felipe  
14900 LUCENA  
957 975 151

[info@apicecool.com](mailto:info@apicecool.com)  
[apicecool.com](http://apicecool.com)