

IBK-1

ICE BAGGER KIT

FEATURES CARACTERÍSTICAS

- ▶ **THE ITV IBK-1 ICE BAGGER WILL MAKE YOUR ICE BAGGING A QUICK AND EASY OPERATION.**
LA EMBOLSADORA DE HIELO ITV IBK-1 HARÁ QUE EMBOLSAR EL HIELO SEA UNA OPERACIÓN RÁPIDA Y FÁCIL.
- ▶ **MADE OF ANODIZED ALUMINIUM.**
FABRICADA CON ALUMINIO ANODIZADO.
- ▶ **ICE CHUTE TUBE MADE OF POLYSTYRENE FOR ALIMENTARY PURPOSES.**
TUBO CÁIDA HIELO DE POLIESTIRENO ALIMENTARIO.
- ▶ **BAGS WITH A CAPACITY OF 4KG (275X550MM).**
BOLSAS CON CAPACIDAD DE 4KG (275X550MM).
- ▶ **ZIPPER BAGS WITH LAMINATED WIRE.**
CIERRE BOLSAS MEDIANTE ALAMBRE PLASTIFICADO.
- ▶ **COMPLEMENT: 2 KIT OF 50 BAGS & ZIPPERS.**
DOTACIÓN: 2 KIT DE 50 BOLSAS & CIERRES.

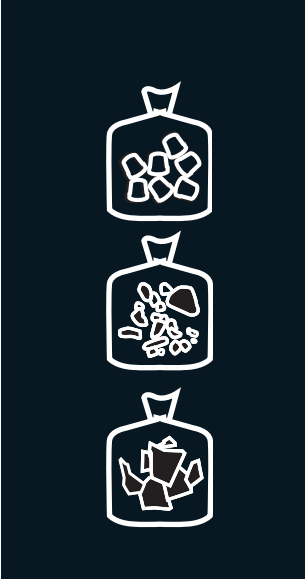

ACCESSORIES ACCESORIOS

INCLUDED



BAGS KIT
KIT DE BOLSAS



ZIPPERS KIT
KIT DE CIERRES



SCOOP
PALA

RECOMMENDED BINS SILOS RECOMENDADOS



S 160



S 220



S 350



S 400





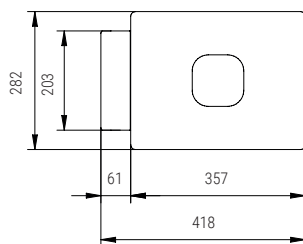
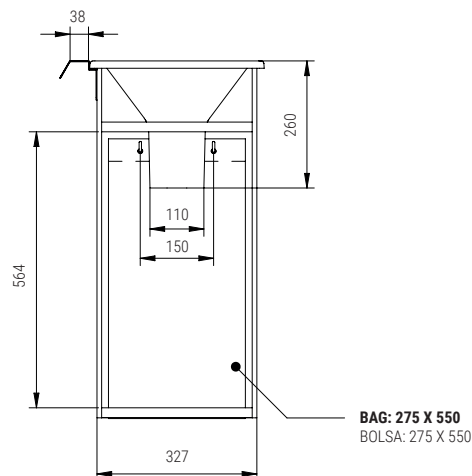
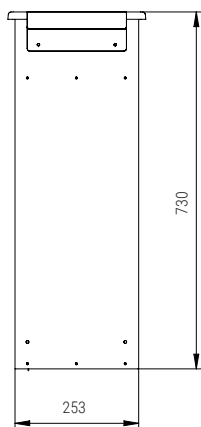





S 500



* All measurements in mm.
* Todas las cotas en mm.

MODELS
MODELOS

IBK-1

	 (mm)	 (Kg)	 (Lbs.)	 (mm)	 (mm)	 (Kg)	 (Kg)	 (m ³)
Width	550	4	8,8	Width	377	5,85	7	0,08
Depth	-			Depth	302			
Height	80			Height	742			