

BIN SCD400

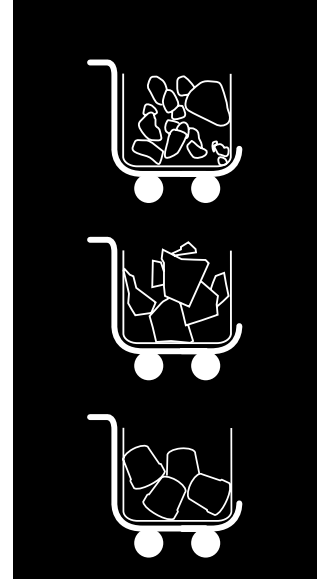









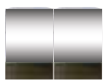



ICE BIN WITH CARTS FOR MODULAR MACHINES

FEATURES CARACTERÍSTICAS

- ▶ **ICE BIN CAPACITY OF 413 KG (CART CAPACITY NOT INCLUDED)**
DEPÓSITO PARA HIELO CON CAPACIDAD DE 413 KG (CAPACIDAD DE LOS CARROS NO INCLUIDA)
- ▶ **AISI 304 STAINLESS STEEL BIN**
DEPÓSITO DE ACERO INOXIDABLE CALIDAD AISI 304
- ▶ **HARD SANITARY POLYETHYLENE VAT, RESISTANT TO BLOWS, AND SCRATCHES**
CUBA INTERIOR DE POLIETILENO SANITARIO DE GRAN DUREZA, RESISTENTE A GOLPES, Y ROCES
- ▶ **EASY CLEANING DESIGN®: SEAMLESS ONE-PIECE VAT WITH ROUNDED CORNERS, AVOIDING POSSIBLE DIRTY POINTS AND FACILITATING CLEANING**
EASY CLEANING DESIGN®: CUBA INTERIOR SIN JUNTAS, DE UNA SOLA PIEZA, CON ESQUINAS REDONDEADAS, ELIMINANDO POSIBLES PUNTOS DE SUCIEDAD Y FACILITANDO LA LIMPIEZA
- ▶ **DRAINAGE SYSTEM THAT COLLECTS AND DRIVES THE WATER TO THE DRAIN KEEPING THE BIN AND FLOOR CLEAN & DRY**
SISTEMA DE DRENAJE QUE RECOGE Y CONDUCE EL AGUA AL DESAGÜE MANTENIENDO TANTO EL DEPÓSITO Y COMO SUELO LIMPIOS Y SECOS
- ▶ **LARGE CAPACITY EASY CART®, UP TO 112 KG OF ICE (70 KG WITH BUCKETS); ERGONOMIC, EASY TO MOVE WITH LITTLE EFFORT**
EASY CART® DE GRAN CAPACIDAD, HASTA 112 KG DE HIELO (70 KG CON CESTAS) Y ERGONÓMICOS, FÁCILES DE MOVER SIN APENAS ESFUERZO
- ▶ **EASY CART® HAS A BRAKING AND DRAINAGE SYSTEM**
EASY CART® DISPONE DE SISTEMA DE FRENADO Y DESAGÜE
- ▶ **EASY CART® IS MADE OF SANITARY POLYETHYLENE, WITH SMOOTH SURFACE TO FACILITATE CLEANING. IT INCLUDES A COVER TO PREVENT DIRT FROM CONTAMINATING THE ICE**
EASY CART® EN POLIETILENO SANITARIO, SIN RUGOSIDADES PARA FACILITAR LA LIMPIEZA. INCLUYE TAPA PARA QUE EL POLVO NO CONTAMINE EL HIELO
- ▶ **BUCKETS FOR DISTRIBUTING ICE QUICKLY AND EFFORTLESSLY CAN BE INCLUDED**
SE PUEDEN INCLUIR CESTAS PARA REPARTIR EL HIELO RÁPIDAMENTE Y SIN ESFUERZO



RECOMMENDED MACHINES MÁQUINAS RECOMENDADAS

	MDP150/MR400/MP	SPIKA	QUASAR	ICE QUEEN	SCALA
RECOMMENDED RECOMENDADO	 2 MDP150 MR400  2 MP145	 1/2 MS220  1/2 MS410  MS300 SLIM		 1/2 IQ200 1/2 IQ400  1/2 IQ550 IQ550 SPLIT IQ850 CO2 SPLIT  IQ1100 IQ1100 SPLIT	 SCALA 400 SCALA 600 SCALA 400 SPLIT SCALA 600 SPLIT  SCALA 1000/1500/2000/3000 SPLIT
NOT RECOMMENDED NO RECOMENDADO	 MDP150  MP145		 1/2 MQ200  1/2 IQ150  2 IQ550 SPLIT 2 IQ850 CO2SPLIT		 SCALA 1000

TECHNICAL SCHEME ESQUEMA TÉCNICO

BIN SCD400



RIGHT SIDE VIEW
VISTA LATERAL DERECHA

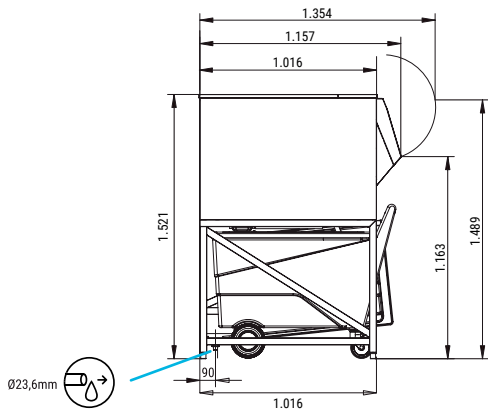

FRONTAL VIEW
VISTA FRONTAL

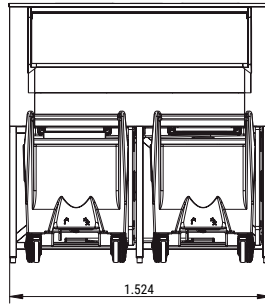

REAR VIEW
VISTA TRASERA

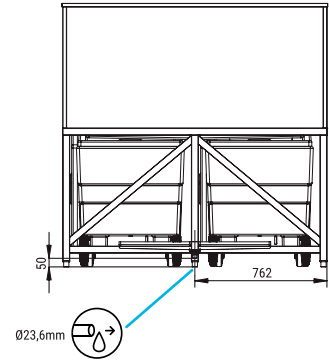

UPPER VIEW
VISTA SUPERIOR

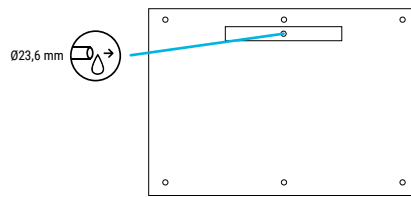

* All measurements in mm.
* Todas las cotas en mm.

ACCESSORIES ACCESORIOS

INCLUDED



WATER OUTLET HOSE
MANGUERA DE DESAGÜE



LARGE SCOOP
PALA GRANDE



ICE PADDLE
PALA DE MANGO LARGO



ICE PADDLE SUPPORT
SOPORTE PARA PALA

NOT INCLUDED (OPTIONAL)



BUCKETS
CESTAS

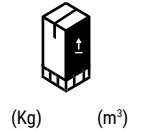

BIN SCD400

413

330

637

Width 1.524
Depth 1.016*
Height 1.520

140

Width 1.630
Depth 1.240
Height 1.660

235 3,36

*WITHOUT DOOR SIN PUERTA



ITV ICE MAKERS, S.L.
POL. IND. SECTOR 13, AVDA. DELS HOSTALERS, 2
46394 RIBARROJA DE TURIA, VALENCIA, SPAIN
PHONE: +34 96 166 75 75 | FAX: +34 96 166 81 00
info@itv.es | www.itv.es



SERVICE
SERVICIO ASISTENCIA TÉCNICA
service@itv.es
Skype: ITV.Service
+34 961 667 639
8:00AM | 7:00PM



Subject to certain limitations
and exclusions. Only spare parts.
Sujeto a limitaciones y exclusiones.
Solo piezas de repuesto.

