

# BIN SCD600

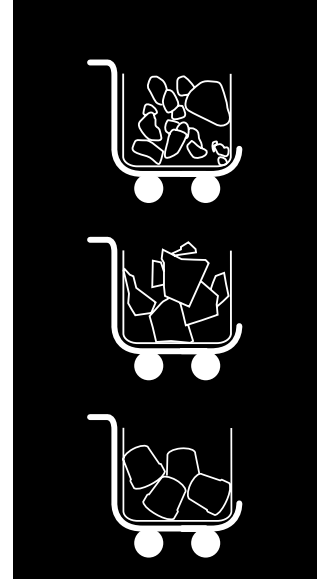



















## ICE BIN WITH CARTS FOR MODULAR MACHINE

### FEATURES CARACTERÍSTICAS

- ▶ **ICE BIN CAPACITY OF 617 KG (CART CAPACITY NOT INCLUDED)**  
DEPÓSITO PARA HIELO CON CAPACIDAD DE 671 KG (CAPACIDAD DE LOS CARROS NO INCLUIDA)
- ▶ **AISI 304 STAINLESS STEEL BIN**  
DEPÓSITO DE ACERO INOXIDABLE CALIDAD AISI 304
- ▶ **HARD SANITARY POLYETHYLENE VAT, RESISTANT TO BLOWS, AND SCRATCHES**  
CUBA INTERIOR DE POLIETILENO SANITARIO DE GRAN DUREZA, RESISTENTE A GOLPES, Y ROCES
- ▶ **EASY CLEANING DESIGN®: SEAMLESS ONE-PIECE VAT WITH ROUNDED CORNERS, AVOIDING POSSIBLE DIRTY POINTS AND FACILITATING CLEANING**  
EASY CLEANING DESIGN®: CUBA INTERIOR SIN JUNTAS, DE UNA SOLA PIEZA, CON ESQUINAS REDONDEADAS, ELIMINANDO POSIBLES PUNTOS DE SUCIEDAD Y FACILITANDO LA LIMPIEZA
- ▶ **DRAINAGE SYSTEM THAT COLLECTS AND DRIVES THE WATER TO THE DRAIN KEEPING THE BIN AND FLOOR CLEAN & DRY**  
SISTEMA DE DRENAJE QUE RECOGE Y CONDUCE EL AGUA AL DESAGÜE MANTENIENDO TANTO EL DEPÓSITO Y COMO SUELO LIMPIOS Y SECOS
- ▶ **LARGE CAPACITY EASY CART®, UP TO 112 KG OF ICE (70 KG WITH BUCKETS); ERGONOMIC, EASY TO MOVE WITH LITTLE EFFORT**  
EASY CART® DE GRAN CAPACIDAD, HASTA 112 KG DE HIELO (70 KG CON CESTAS) Y ERGONÓMICOS, FÁCILES DE MOVER SIN APENAS ESFUERZO
- ▶ **EASY CART® HAS A BRAKING AND DRAINAGE SYSTEM**  
EASY CART® DISPONE DE SISTEMA DE FRENADO Y DESAGÜE
- ▶ **EASY CART® IS MADE OF SANITARY POLYETHYLENE, WITH SMOOTH SURFACE TO FACILITATE CLEANING. IT INCLUDES A COVER TO PREVENT DIRT FROM CONTAMINATING THE ICE**  
EASY CART® EN POLIETILENO SANITARIO, SIN RUGOSIDADES PARA FACILITAR LA LIMPIEZA. INCLUYE TAPA PARA QUE EL POLVO NO CONTAMINE EL HIELO
- ▶ **BUCKETS FOR DISTRIBUTING ICE QUICKLY AND EFFORTLESSLY CAN BE INCLUDED**  
SE PUEDEN INCLUIR CESTAS PARA REPARTIR EL HIELO RÁPIDAMENTE Y SIN ESFUERZO

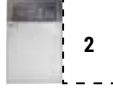

### RECOMMENDED MACHINES MÁQUINAS RECOMENDADAS

|                                       | MDP150/MR400/MP   | SPIKA  | QUASAR   | ICE QUEEN   | SCALA  |
|---------------------------------------|---|--|--|---|--|
| <b>RECOMMENDED RECOMENDADO</b>        | <br>2 MDP150<br><br><br>MR400   | <br>2 MS220<br><br><br>1 2 MS410 |  | <br>1 2 IQ400<br><br><br>1 2 IQ550<br><br><br>1 2 IQ550 SPLIT<br><br><br>IQ1100<br><br><br>IQ1100 SPLIT | <br>SCALA 400<br>SCALA 400 SPLIT<br><br><br>SCALA 600<br>SCALA 600 SPLIT<br><br><br>SCALA 1000/1500/2000/3000 SPLIT |
| <b>NOT RECOMMENDED NO RECOMENDADO</b> | <br>MDP150<br><br><br>1 2 MP145 | <br>MS220<br><br><br>MS300 SLIM  | <br>1 2 MQ200 | <br>1 2 IQ150<br><br><br>1 2 IQ200<br><br><br>2 IQ850 CO2 SPLIT  | <br>SCALA 1000  |



## BIN SCD600

**RIGHT SIDE VIEW**  
VISTA LATERAL DERECHA

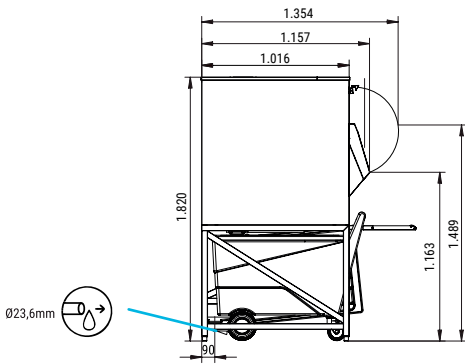

**FRONTAL VIEW**  
VISTA FRONTAL

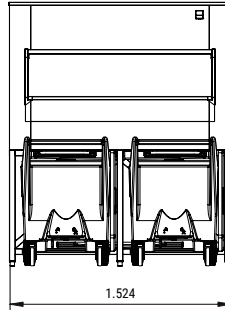

**REAR VIEW**  
VISTA TRASERA

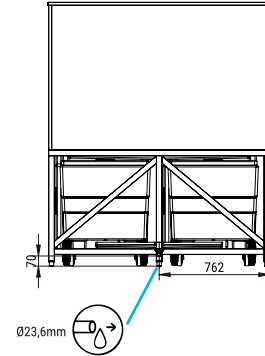

**UPPER VIEW**  
VISTA SUPERIOR

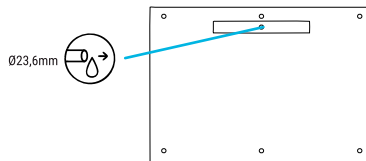

\* All measurements in mm.  
\* Todas las cotas en mm.

## ACCESSORIES ACCESORIOS

**INCLUDED**



**WATER OUTLET HOSE**  
MANGUERA DE DESAGÜE



**LARGE SCOOP**  
PALA GRANDE



**ICE PADDLE**  
PALA DE MANGO LARGO



**ICE PADDLE SUPPORT**  
SOPORTE PARA PALA

**NOT INCLUDED (OPTIONAL)**



**BUCKETS**  
CESTAS

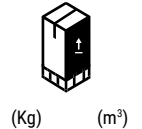

**DEPÓSITO SCD600**

617

494

841

Width 1.524  
Depth 1.016\*  
Height 1.820

160

Width 1.630  
Depth 1.240  
Height 1.980

255

4

\*WITHOUT DOOR SIN PUERTA



ITV ICE MAKERS, S.L.  
POL. IND. SECTOR 13, AVDA. DELS HOSTALERS, 2  
46394 RIBARROJA DE TURIA, VALENCIA, SPAIN  
PHONE: +34 96 166 75 75 | FAX: +34 96 166 81 00  
info@itv.es | www.itv.es



SERVICE  
SERVICIO ASISTENCIA TÉCNICA  
service@itv.es  
Skype: ITV.Service  
+34 961 667 639  
8:00AM | 7:00PM



Subject to certain limitations  
and exclusions. Only spare parts.  
Sujeto a limitaciones y exclusiones.  
Solo piezas de repuesto.

