

ICE QUEEN N 300 230 V / 50 Hz

MODULAR NUGGET ICE MACHINE

FEATURES CARACTERÍSTICAS

- ▶ **PRODUCE NUGGET ICE**
PRODUCE HIELO NUGGET
 - ▶ **HIGH EVAPORATOR EFFICIENCY: LOWER ENERGY CONSUMPTION AND HIGHER ICE PRODUCTION**
EVAPORADOR DE ALTA EFICIENCIA: MENOR GASTO ENERGÉTICO, MAYOR PRODUCCIÓN DE HIELO
 - ▶ **AUTODIAGNOSIS LED LIGHTS SIGNALING OPERATION STATUS & ALERTS**
AUTODIAGNOSIS CON SEÑALIZACIÓN DE LEDS SOBRE EL FUNCIONAMIENTO Y ALERTAS
 - ▶ **ELECTRONIC CONTROL. ON/OFF LIGHTED SWITCH IN FRONT PANEL**
ELECTRONIC CONTROL. BOTÓN ENCENDIDO/APAGADO LUMINOSO EN PANEL FRONTAL
 - ▶ **STAINLESS STEEL AUGER WITH RESILIENT COATING TO MAXIMIZE LIFESPAN**
HUSILLO DE ACERO INOXIDABLE CON POSTERIOR TRATAMIENTO SUPERFICIAL PARA AUMENTAR SU VIDA ÚTIL
 - ▶ **POWERFUL MOTOR GEAR**
POTENTE MOTOR REDUCTOR
 - ▶ **AISI 304 STAINLESS STEEL BODY**
CARROCERÍA EN ACERO INOXIDABLE AISI 304
 - ▶ **OPTICAL PINPOINT CONTROL SYSTEM TO SET ICE STOCK LEVEL. ICE DROPS OUT THROUGH THE OPENING ON THE BOTTOM OF THE UNIT**
REGULACIÓN DEL STOCK DE HIELO MEDIANTE UN SISTEMA DE CONTROL ÓPTICO DE PRECISIÓN. EL HIELO SALE POR UNA ABERTURA EN LA PARTE INFERIOR DE LA UNIDAD
 - ▶ **TROPICALIZED MACHINES (T CLASS)**
MÁQUINAS TROPICALIZADAS (CLASE T)
 - ▶ **NATURAL GAS R290 WITH VERY LOW GLOBAL WARMING POTENTIAL WHICH ALSO REDUCES THE ENERGY CONSUMPTION**
GAS NATURAL R290 CON MUY BAJO ÍNDICE GWP EL CUAL TAMBIÉN REDUCE EL CONSUMO ENERGÉTICO
- THE INSTALLATION OF AN ANTI-SCALE FILTER AND PERIODIC CLEANING ARE ADVISED IN AREAS WITH MEDIUM OR HIGH LIMESCALE CONTENT (HARD WATER)**
SE ACONSEJA LA INSTALACIÓN DE UN FILTRO ANTICAL Y LIMPIEZA PERIÓDICA EN CASO DE AGUAS CON CONTENIDO EN CAL MEDIO O ALTO (AGUAS DURAS)

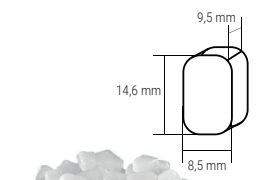

NUGGET ICE
90% DRY (+/-2%)

	 Kg	 (Kg)	 (Kg)	 (mm)	 (mm)
IQ N 300 A		378	330	Width 559 Depth 622 Height 712	Width 636 Depth 695 Height 835
IQ N 300 W		-	-		

ACCESSORIES ACCESORIOS

INCLUDED			NOT INCLUDED (OPTIONAL)			
WATER INLET FILTER GASKET JUNTA DE FILTRO DE ENTRADA DE AGUA	WATER INLET HOSE MANGUERA DE ENTRADA DE AGUA	WATER OUTLET HOSE MANGUERA DE DE DRENAJE	LARGE SCOOP PALA GRANDE	ICE DELIVERY CHUTE TUBO CAÍDA DE HIELO	DISPERSION CONE CONO DE DISPERSIÓN	EXTERNAL STOP FULL BIN PHOTO CELL SENSOR DE PARO EXTERNO POR LLENADO
			ANTI-LIMESCALE FILTER FILTRO ANTICAL	PARTICLE FILTER FILTRO ANTIPARTÍCULAS		

RECOMMENDED BINS DEPÓSITOS RECOMENDADOS



ICE QUEEN N 300

RIGHT SIDE VIEW
VISTA LATERAL DERECHA

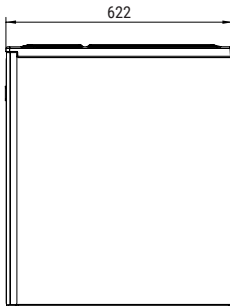

FRONTAL VIEW
VISTA FRONTAL

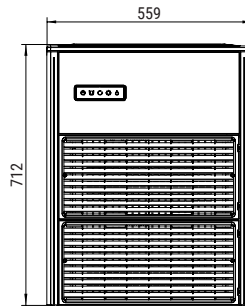

REAR VIEW
VISTA TRASERA

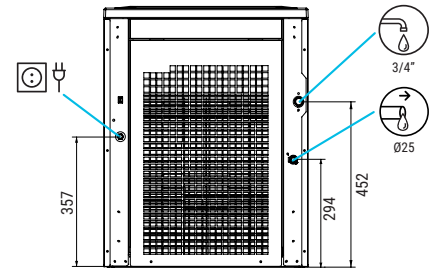

CENTRAL CROSS SECTION
VIEW OF THE BASE
VISTA DE LA BASE DESDE
SECCIÓN CENTRAL

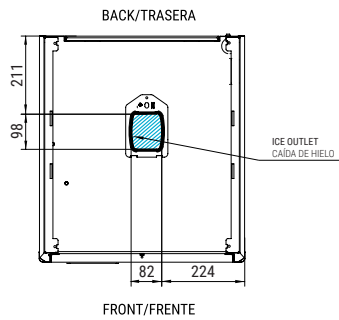

* All measurements in mm.
* Todas las cotas en mm.

OPERATING CONDITIONS CONDICIONES DE TRABAJO

PRODUCTION 50Hz PRODUCCIÓN 50 Hz

±10% V

10°C/43°C

5°C/38°C

1 bar/6 bar

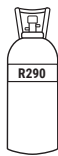

V	Hz	ph
230	50	1N

IQ N 300 AIR COOLED

	Kg				
	10°	15°	21°	30°	
°C	50°	60°	70°	86°	
10°	378	370	360	350	
21°	368	330	327	320	
32°	325	310	304	298	
43°	285	270	261	255	
109°					

IQ N 300 WATER COOLED

	Kg				
	10°	15°	21°	30°	
°C	50°	60°	70°	86°	
10°	-	-	-	-	
21°	-	-	-	-	
32°	-	-	-	-	
43°	-	-	-	-	
109°	-	-	-	-	

MODELS
MODELOS

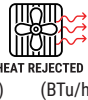

IQ N 300 A



3.240 11.055

1.316

3

1,5

16

7,9

15,2

2.544 8.680

84

93

0,37

IQ N 300 W



- -

-

-

-

-

-

-

- -

-

-

-



ITV ICE MAKERS, S.L.
POL. IND. SECTOR 13, AVDA. DELS HOSTALERS, 2
46394 RIBARROJA DE TURIA, VALENCIA, SPAIN
PHONE: +34 96 166 75 75 | FAX: +34 96 166 81 00
info@itv.es | www.itv.es



SERVICE
SERVICIO ASISTENCIA TÉCNICA
service@itv.es
Skype: ITV.Service
+34 961 667 639
8:00AM | 7:00PM



Subject to certain limitations
and exclusions. **Only spare parts.**
Sujeto a limitaciones y exclusiones.
Solo piezas de repuesto.

