

## SCALA 3000 REMOTE







THREE PHASE  
400 V / 50 Hz

### MODULAR FLAKE ICE MACHINE WITH REMOTE UNIT

#### FEATURES CARACTERÍSTICAS

- ▶ **PRODUCES COLD AND DRY FLAT FLAKES. FLAKE THICKNESS MAY BE ADJUSTED BETWEEN 1.5 mm AND 3 mm**  
PRODUCE ESCAMAS PLANAS MUY FRÍAS Y SECAS. EL ESPESOR PUEDE REGULARSE ENTRE 1.5 Y 3 mm
- ▶ **BASED ON A STATIC CYLINDER WHICH IS FREE FROM SWIVEL JOINTS (HELICAL REAMER) COUPLED WITH A MILLING TOOL THAT DETACHES THE ICE WITHOUT ANY STRAINED OR FORCED MOVEMENTS**  
FUNCIONAMIENTO BASADO EN UN CILINDRO ESTÁTICO SIN JUNTAS GIRATORIAS (HELICAL REAMER) Y CON UNA FRESA QUE DESPEGA EL HIELO SIN TENSIONES NI ESFUERZOS
- ▶ **THE MOST EFFICIENT EVAPORATOR OF THE MARKET, LESS ENERGY CONSUMPTION AND HIGHER ICE PRODUCTION**  
EL EVAPORADOR MAS EFICIENTE DEL MERCADO, MENOR GASTO ENERGÉTICO, MAYOR PRODUCCIÓN DE HIELO
- ▶ **ELECTRONIC STOP SYSTEM / ELECTRICAL CONTROL PANEL / DRIVE DIRECT GEAR MOTOR / MAGNETIC DRIVE PUMP / LOW WATER SAFETY DEVICE**  
SISTEMA DE PARO ELECTRÓNICO / CUADRO ELÉCTRICO DE REGULACIÓN / MOTORREDUCTOR DE ATAQUE DIRECTO / BOMBA DE ARRASTRE MAGNÉTICO / SEGURIDAD ANTE FALTA DE AGUA
- ▶ **STAINLESS STEEL SOLEPLATE**  
BANCADA DE ACERO INOXIDABLE
- ▶ **CONTROLLERS TO DETECT: LOW WATER LEVEL, TEMPERATURE RISE DUE TO MOTOR OVERLOAD OR FULL VAT**  
CONTROLES PARA DETECTAR: FALTA DE NIVEL DE AGUA, AUMENTO DE TEMPERATURA POR SOBRESFUERZO EN EL MOTORREDUCTOR O POR LLENADO DE ALMACÉN

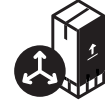

	 24 H	 10°C (Kg)	 15°C (Kg)	 (mm)	 (mm)	
SCALA 3000 SPLIT		3.300	3000	Width 1.050 Depth 750 Height 1.300	Width 1.150 Depth 975 Height 1.330	 <b>FLAKE ICE</b> -7°C Ice Temperature
RCU 3000	-	-	-	Width 1.250 Depth 1.500 Height 1.300	Width 1.800 Depth 1.450 Height 1.300	

#### ACCESSORIES ACCESORIOS

##### INCLUDED



**WATER INLET FILTER GASKET**  
JUNTA DE FILTRO DE ENTRADA DE AGUA

**WATER INLET HOSE**  
MANGUERA DE ENTRADA DE AGUA

**WATER OUTLET HOSE**  
MANGUERA DE DESAGÜE

##### OPTIONAL (NOT INCLUDED)

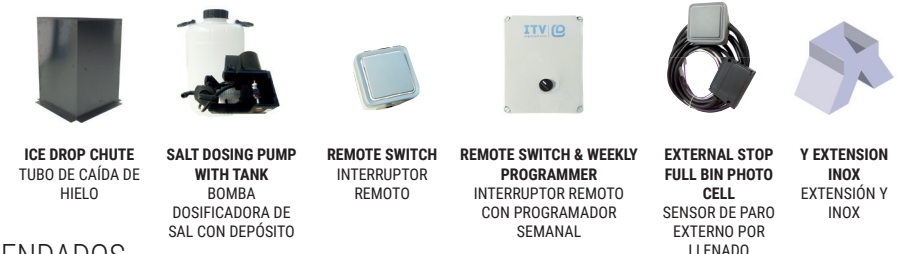

**ICE DROP CHUTE**  
TUBO DE CAÍDA DE HIELO

**SALT DOSING PUMP WITH TANK**  
BOMBA DOSIFICADORA DE SAL CON DEPÓSITO

**REMOTE SWITCH**  
INTERRUPTOR REMOTO

**REMOTE SWITCH & WEEKLY PROGRAMMER**  
INTERRUPTOR REMOTO CON PROGRAMADOR SEMANAL

**EXTERNAL STOP FULL BIN PHOTO CELL**  
SENSOR DE PARO EXTERNO POR LLENADO

**Y EXTENSION**  
EXTENSIÓN Y INOX

#### RECOMMENDED BINS DEPÓSITOS RECOMENDADOS



SS00 + SCALA 3000 SPLIT

SCD400 + SCALA 3000 SPLIT

SCD600 + SCALA 3000 SPLIT

SCD800 + SCALA 3000 SPLIT

SS221 + SCALA 3000 CO2 SPLIT

SS422 + SCALA 3000 CO2 SPLIT

## SCALA 3000 SPLIT

**RIGHT SIDE VIEW**  
VISTA LATERAL DERECHA

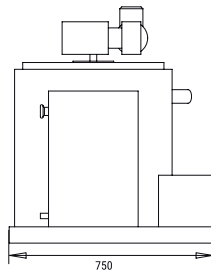

**FRONTAL VIEW**  
VISTA FRONTAL

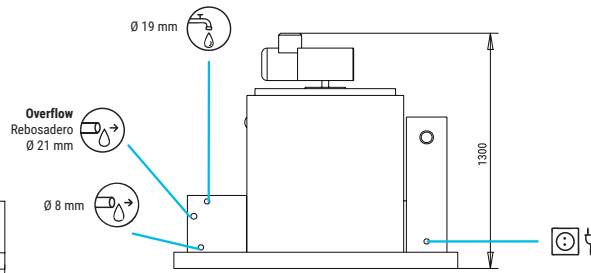

**LEFT SIDE VIEW**  
VISTA LATERAL IZQUIERDA

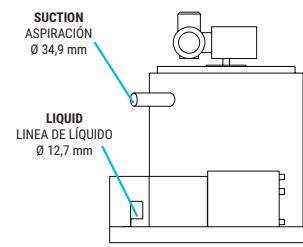

## RCU 3000

**CENTRAL CROSS SECTION VIEW OF THE BASE**  
VISTA DE LA BASE DESDE SECCIÓN CENTRAL

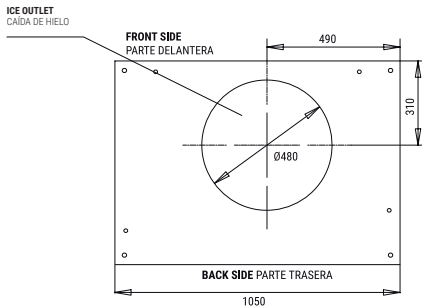

**RIGHT SIDE VIEW**  
VISTA LATERAL DERECHA

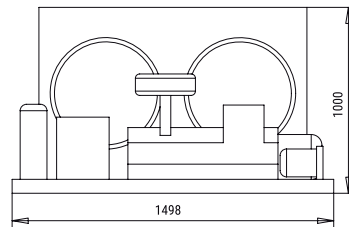

**RIGHT SIDE VIEW**  
VISTA LATERAL DERECHA

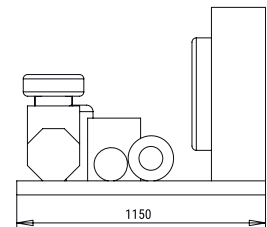

\* All measurements in mm.  
\* Todas las cotas en mm.

## OPERATING CONDITIONS CONDICIONES DE TRABAJO

PRODUCTION 50Hz PRODUCCIÓN 50 Hz

±10% V

10°C/43°C

5°C/38°C

1 bar/6 bar

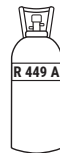

V	Hz	ph
400	50	3N



SCALA 3000 REMOTE

°C	10°	15°	21°	30°
°F	50°	60°	70°	86°
10°	3300	3100	2700	2500
50°				
21°	3270	3000	2600	2370
68°				
32°	3100	2800	2400	2150
90°				
43°	2550	2370	1950	1800
109°				



SCALA 3000 REMOTE

°C	10°	15°	21°	30°
°F	50°	60°	70°	86°
10°	3069	2883	2511	2325
50°				
21°	3041	2790	2418	2204
68°				
32°	2883	2604	2232	2000
90°				
43°	2372	2204	1814	1674
109°				

## MODELS MODELOS

	Temp.EV. (°C)	ASHRAE CONDITIONS (W) (BTU/h)	(W) 43°C	(n.) (mm <sup>2</sup> )	FUSE	100 Kg (Kw/h)	(l/h)	HEAT REJECTED (W) (BTU/h)	(Kg)	(Kg)	(m <sup>3</sup> )
SCALA 3000 S	-22	16.500 56.300	200	3 6	32	7,8	16,6	- -	280	320	1,27
RCU 3000	-	- -	12.150	5 6	32	-	-	19.800 67.560	360	400	2,64



ITV ICE MAKERS, S.L.  
POL. IND. SECTOR 13, AVDA. DELS HOSTALERS, 2  
46394 RIBARROJA DE TURIA, VALENCIA, SPAIN  
PHONE: +34 96 166 75 75 | FAX: +34 96 166 81 00  
info@itv.es | www.itv.es



SERVICE  
SERVICIO ASISTENCIA TÉCNICA  
service@itv.es  
Skype: ITV.Service  
+34 961 667 639  
8:00AM | 7:00PM



Subject to certain limitations and exclusions. Only spare parts.  
Sujeto a limitaciones y exclusiones. Solo piezas de repuesto.



9000  
9001  
14000

